



Standard Test Method for Microindentation Hardness of Materials¹

This standard is issued under the fixed designation E 384; the number immediately following the designation indicates the year of original adoption or, in the case of revision, the year of last revision. A number in parentheses indicates the year of last reapproval. A superscript epsilon (ϵ) indicates an editorial change since the last revision or reapproval.

This standard has been approved for use by agencies of the Department of Defense.

1. Scope

1.1 This test method covers determination of the microindentation hardness of materials, the verification of microindentation hardness testing machines, and the calibration of standardized test blocks.

1.2 This test method covers microindentation tests made with Knoop and Vickers indenters under test forces in the range from 9.8×10^{-3} to 9.8 N (1 to 1000 gf).

1.3 This test method includes an analysis of the possible sources of errors that can occur during microindentation testing and how these factors affect the accuracy, repeatability, and reproducibility of test results.

NOTE 1—While Committee E04 is primarily concerned with metals, the test procedures described are applicable to other materials.

1.4 *This standard does not purport to address all of the safety concerns, if any, associated with its use. It is the responsibility of the user of this standard to establish appropriate safety and health practices and determine the applicability of regulatory limitations prior to use.*

2. Referenced Documents

2.1 ASTM Standards:²

C 1326 Test Method for Knoop Indentation Hardness of Advanced Ceramics

C 1327 Test Method for Vickers Indentation Hardness of Advanced Ceramics

E 3 Methods of Preparation of Metallographic Specimens

E 7 Terminology Relating to Metallography

E 122 Practice for Choice of Sample Size to Estimate the Average Quality for a Lot or Process

E 140 Test Method for Hardness Conversion Tables for Metals

E 175 Terminology of Microscopy

¹ This test method is under the jurisdiction of ASTM Committee E04 on Metallography and is the direct responsibility of Subcommittee E04.05 on Microhardness.

Current edition approved August 15, 2005. Published September 2005. Originally approved in 1969. Last previous edition approved in 2005 as E 384 – 05.

² For referenced ASTM standards, visit the ASTM website, www.astm.org, or contact ASTM Customer Service at service@astm.org. For *Annual Book of ASTM Standards* volume information, refer to the standard's Document Summary page on the ASTM website.

E 691 Practice for Conducting an Interlaboratory Study to Determine the Precision of a Test Method

E 766 Practice for Calibrating the Magnification of a Scanning Electron Microscope

3. Terminology

3.1 *Definitions*—For definitions of terms used in this test method, see Terminology **E 7**.

3.2 *Definitions of Terms Specific to This Standard:*

3.2.1 *calibrating, v*—determining the values of the significant parameters by comparison with values indicated by a reference instrument or by a set of reference standards.

3.2.2 *Knoop hardness number, HK, n*—an expression of hardness obtained by dividing the force applied to the Knoop indenter by the projected area of the permanent impression made by the indenter.

3.2.3 *Knoop indenter, n*—a rhombic-based pyramidal-shaped diamond indenter with edge angles of $\angle A = 172^\circ 30'$ and $\angle B = 130^\circ 0'$ (see **Fig. 1**).

3.2.4 *microindentation hardness test, n*—a hardness test using a calibrated machine to force a diamond indenter of specific geometry into the surface of the material being evaluated, in which the test forces range from 1 to 1000 gf (9.8×10^{-3} to 9.8 N), and the indentation diagonal, or diagonals are measured with a light microscope after load removal; for any microindentation hardness test, it is assumed that the indentation does not undergo elastic recovery after force removal.

NOTE 2—Use of the term microhardness should be avoided because it implies that the hardness, rather than the force or the indentation size, is very low.

3.2.5 *verifying, v*—checking or testing the instrument to assure conformance with the specification.

3.2.6 *Vickers hardness number, HV, n*—an expression of hardness obtained by dividing the force applied to a Vickers indenter by the surface area of the permanent impression made by the indenter.

3.2.7 *Vickers indenter, n*—a square-based pyramidal-shaped diamond indenter with face angles of 136° (see **Fig. 2**).

3.3 *Formulae*—The formulae presented in **3.3.1-3.3.4** for calculating microindentation hardness are based upon an ideal tester. The measured value of the microindentation hardness of a material is subjected to several sources of errors. Based on Eq

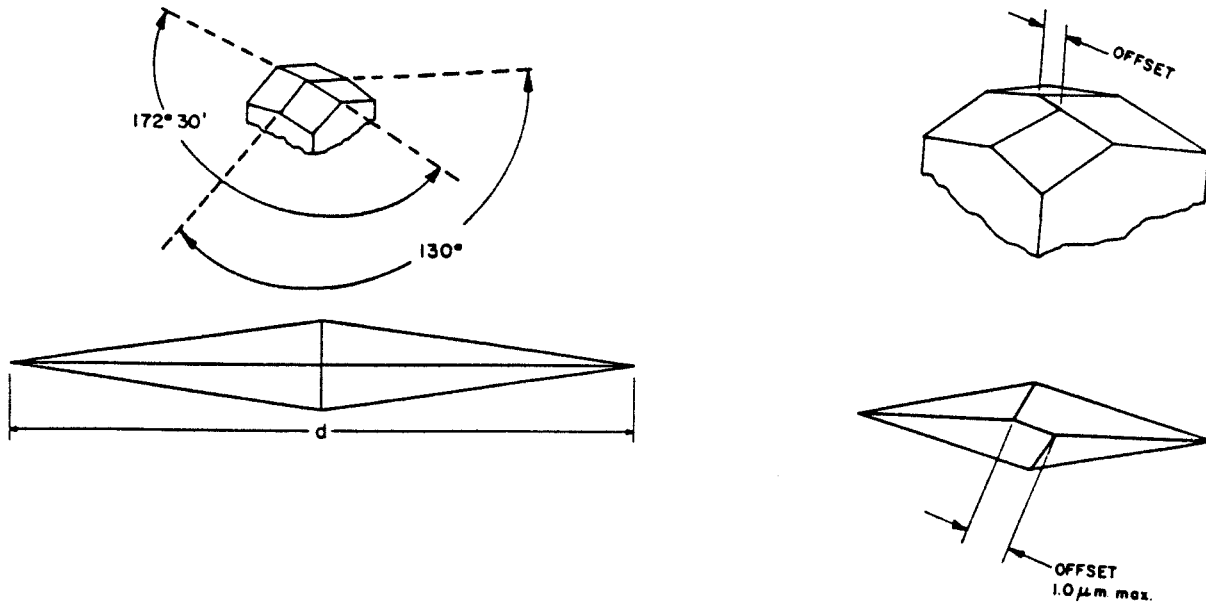

FIG. 1 Knoop Indenter

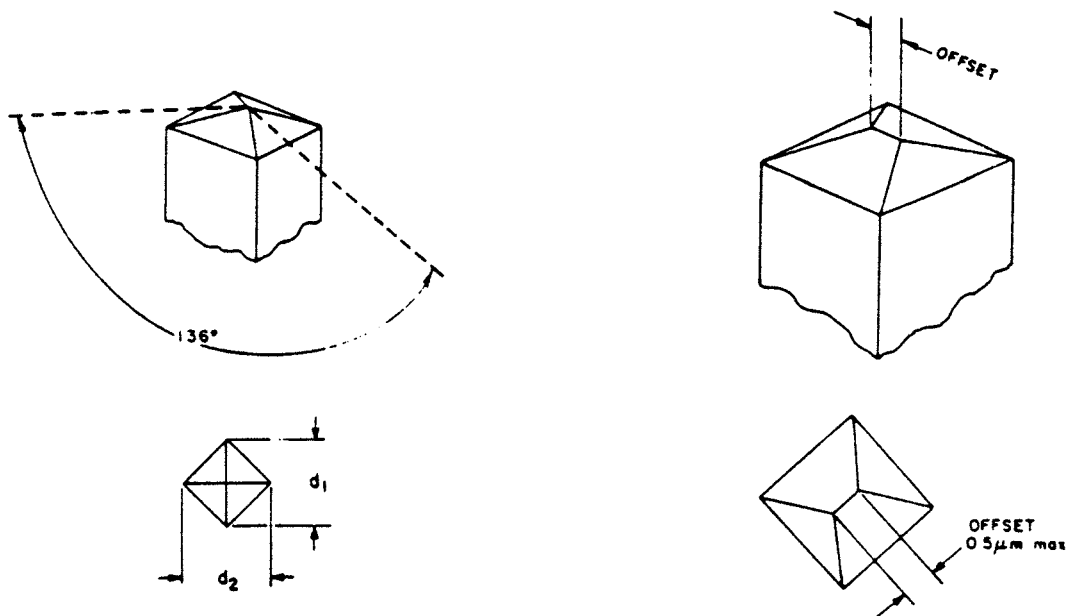

FIG. 2 Vickers Indenter

1-9, variations in the applied force, geometrical variations between diamond indenters, and human errors in measuring indentation lengths can affect the calculated material hardness. The amount of error each of these parameters has on the calculated value of a microindentation measurement is discussed in Section 10.

3.3.1 For Knoop hardness tests, in practice, test loads are in grams-force and indentation diagonals are in micrometers. The Knoop hardness number is calculated using the following:

$$HK = 1.000 \times 10^3 \times (P/A_p) = 1.000 \times 10^3 \times P/(c_p \times d^2) \quad (1)$$

or

$$HK = 14229 \times P/d^2 \quad (2)$$

$$c_p = \frac{\tan\left(\frac{\angle B}{2}\right)}{2 \tan\left(\frac{\angle A}{2}\right)} \quad (3)$$

where:

- P = force, gf,
- d = length of long diagonal, μm ,
- A_p = projected area of indentation, μm^2 ,
- $\angle A$ = included longitudinal edge angle, $172^\circ 30'$,

- $\angle B$ = included transverse edge angle, $130^\circ 0'$ (see Fig. 1), and
 c_p = indenter constant relating projected area of the indentation to the square of the length of the long diagonal, ideally 0.07028.

NOTE 3—HK values for a 1-gf (9.8×10^{-3} N) test are contained in Appendix X6. To obtain HK values when other test forces are employed, multiply the HK value from Table X6.1 for the d value by the actual test force, g.

3.3.2 The Knoop hardness, kgf/mm² is determined as follows:

$$HK = 14.229 \times P_1/d_1^2 \quad (4)$$

where:

- P_1 = force, kgf, and
 d_1 = length of long diagonal, mm.

3.3.3 The Knoop hardness reported with units of GPa is determined as follows:

$$HK = 0.014229 \times P_2/d_2^2 \quad (5)$$

where:

- P_2 = force, N, and
 d_2 = length of the long diagonal of the indentation, mm.

3.3.4 For the Vickers hardness test, in practice, test loads are in grams-force and indentation diagonals are in micrometres. The Vickers hardness number is calculated as follows:

$$HV = 1.000 \times 10^3 \times P/A_s = 2.000 \times 10^3 \times P \sin(\alpha/2)/d^2 \quad (6)$$

or

$$HV = 1854.4 \times P/d^2 \quad (7)$$

where:

- P = force, gf,
 A_s = surface area of the indentation, μm^2 ,
 d = mean diagonal length of the indentation, μm , and
 α = face angle of the indenter, $136^\circ 0'$ (see Fig. 2).

NOTE 4—HV numbers for a 1-gf (9.8×10^{-3} N) test load are contained in Appendix X6. To obtain HV values when other test forces are employed, multiply the HV value from Table X6.2 for the d value by the actual test force, g.

3.3.5 The Vickers hardness, kgf/mm² is determined as follows:

$$HV = 1.8544 \times P_1/d_1^2 \quad (8)$$

where:

- P_1 = force, kgf, and
 d_1 = length of long diagonal, mm.

3.3.6 The Vickers hardness reported with units of GPa is determined as follows:

$$HV = 0.0018544 \times P_2/d_2^2 \quad (9)$$

where:

- P_2 = force, N, and
 d_2 = length of the long diagonal of the indentation, mm.

4. Summary of Test Method

4.1 In this test method, a hardness number is determined based on the formation of a very small indentation by appli-

cation of a relatively low force, in comparison to ordinary indentation hardness tests.

4.2 A Knoop or Vickers indenter, made from diamond of specific geometry is pressed into the test specimen surface under an applied force in the range of 1 to 1000 gf using a test machine specifically designed for such work.

4.3 The size of the indentation is measured using a light microscope equipped with a filar type eyepiece, or other type of measuring device (see Terminology E 175).

4.4 The Knoop hardness number is based upon the force divided by the projected area of the indentation. The Vickers hardness number is based upon the force divided by the surface area of the indentation.

4.5 It is assumed that elastic recovery does not occur when the indenter is removed after the loading cycle, that is, it is assumed that the indentation retains the shape of the indenter after the force is removed. In Knoop testing, it is assumed that the ratio of the long diagonal to the short diagonal of the impression is the same (see 7.1.4) as for the indenter.

5. Significance and Use

5.1 Hardness tests have been found to be very useful for materials evaluation, quality control of manufacturing processes and research and development efforts. Hardness, although empirical in nature, can be correlated to tensile strength for many metals, and is an indicator of wear resistance and ductility.

5.2 Microindentation tests extend hardness testing to materials too thin or too small for macroindentation tests. Microindentation tests allow specific phases or constituents and regions or gradients too small for macroindentation testing to be evaluated.

5.3 Because the microindentation hardness will reveal hardness variations that may exist within a material, a single test value may not be representative of the bulk hardness.

6. Apparatus

6.1 *Test Machine*—The test machine must support the test specimen and control the movement of the indenter into the specimen under a preselected test force, and should have a light optical microscope to select the desired test location and to measure the size of the indentation produced by the test. The plane of the surface of the test specimen must be perpendicular to the axis of the indenter and the direction of the force application. The plane of the test surface of test specimen must be level in order to obtain usable information.

6.1.1 *Force Application*—The test machine shall be capable of applying the following forces:

6.1.1.1 The time from the initial application of the force until the full test force is reached shall not exceed 10 s.

6.1.1.2 The indenter shall contact the specimen at a velocity between 15 and 70 $\mu\text{m/s}$.

6.1.1.3 The full test force shall be applied for 10 to 15 s unless otherwise specified.

6.1.1.4 For some applications it may be necessary to apply the test force for longer times. In these instances the tolerance for the time of the applied force is ± 2 s.

6.1.2 *Vibration Control*—During the entire test cycle, the test machine should be protected from shock or vibration. To

minimize vibrations, the operator should avoid contacting the machine in any manner during the entire test cycle.

6.2 *Vickers Indenter*—The Vickers indenter usually produces a geometrically similar indentation at all test forces. Except for tests at very low forces that produce indentations with diagonals smaller than about 25 μm , the hardness number will be essentially the same as produced by Vickers machines with test forces greater than 1 kgf, as long as the material being tested is reasonably homogeneous. For isotropic materials, the two diagonals of a Vickers indentation are equal in size.

6.2.1 The ideal Vickers indenter is a highly polished, pointed, square-based pyramidal diamond with face angles of $136^\circ 0'$. The effect that geometrical variations of these angles have on the measured values of Vickers hardness are discussed in Section 10.

6.2.2 The four faces of the Vickers indenter shall be equally inclined to the axis of the indenter (within $\pm 30'$) and shall meet at a sharp point. The line of junction between opposite faces (offset) shall be not more than 0.5 μm in length as shown in Fig. 2.

6.3 *Knoop Indenter*—The Knoop indenter does not produce a geometrically similar indentation as a function of test force. Consequently, the Knoop hardness will vary with test force. Due to its rhombic shape, the indentation depth is shallower for a Knoop indentation compared to a Vickers indentation under identical test conditions. The two diagonals of a Knoop indentation are markedly different. Ideally, the long diagonal is 7.114 times longer than the short diagonal, but this ratio is influenced by elastic recovery. Thus, the Knoop indenter is very useful for evaluating hardness gradients or thin coatings.

6.3.1 The Knoop indenter is a highly polished, pointed, rhombic-based, pyramidal diamond. The ideal included longitudinal edge angles are $172^\circ 30'$ and $130^\circ 0'$. The ideal indenter constant, c_p , is 0.07028. The effect that geometrical variations of these angles have on the measured values of Knoop hardness are discussed in Section 10.

6.3.2 The four faces of the Knoop indenter shall be equally inclined to the axis of the indenter (within $\pm 30'$) and shall meet at a sharp point. The line of junction between opposite faces (offset) shall be not more than 1.0 μm in length for indentations greater than 20 μm in length, as shown in Fig. 1. For shorter indentations the offset should be proportionately less.

6.3.3 Indenters should be examined periodically and replaced if they become worn, dulled, chipped, cracked or separated from the mounting material.

6.4 *Measuring Equipment*—The test machine's measuring device should report the diagonal lengths in 0.1 μm increments for indentations with diagonals from 1 to 200 μm .

NOTE 5—This is the reported length and not the resolution of the system used for performing the measurements. As an example, if a length of 200 μm corresponds to 300 filar units or pixels, the corresponding calibration constant would be $200/300 = 0.66666667$. This value would be used to compute diagonal lengths, but the reported length would only be reported to the nearest 0.1 μm .

6.4.1 The optical portion of the measuring device should have Köhler illumination (see Appendix X1).

6.4.2 To obtain maximum resolution, the measuring microscope should have adjustable illumination intensity, adjustable alignment and aperture and field diaphragms.

6.4.3 Magnifications should be provided so that the diagonal can be enlarged to greater than 25 % but less than 75 % of the field width.

7. Test Specimen

7.1 For optimum accuracy of measurement, the test should be performed on a flat specimen with a polished or otherwise suitably prepared surface. The surface must be free of any defects that could affect the indentation or the subsequent measurement of the diagonals. Conducting tests on non-planar surfaces is not recommended. Results will be affected even in the case of the Knoop test where the radius of curvature is in the direction of the short diagonal.

7.1.1 In all tests, the indentation perimeter, and the indentation tips in particular, must be clearly defined in the microscope field of view.

7.1.2 The specimen surface should not be etched before making an indentation. Etched surfaces can obscure the edge of the indentation, making an accurate measurement of the size of the indentation difficult. However, when determining the microindentation hardness of an isolated phase or constituent, a light etch can be used to delineate the object of interest. The quality of the required surface finish can vary with the forces and magnifications used in microindentation hardness testing. The lighter the force and the smaller the indentation size, the more critical is the surface preparation. Some materials are more sensitive to preparation-induced damage than others.

7.1.3 Due to the small size of the indentations, special precautions must be taken during specimen preparation. It is well known that improper polishing can alter test results. Specimen preparation must remove any damage introduced during these steps, either due to excessive heating or cold work, for example.

7.1.4 Specimen preparation should be performed in accordance with Methods E 3.

7.2 In some instances, it is necessary to mount the specimen for convenience in preparation. When mounting is required, the specimen must be adequately supported by the mounting medium so that the specimen does not move during force application, that is, avoid the use of polymeric mounting compounds that creep under the indenter force.

8. Procedure

8.1 Turn on the illumination system and power for the tester.

8.2 Select the desired indenter. Refer to the manufacturer's instruction manual if it is necessary to change indenters. Occasionally clean the indenter with a cotton swab and alcohol. Avoid creating static charges during cleaning.

8.3 Place the specimen on the stage or in the stage clamps, so that the specimen surface is perpendicular to the indenter axis.

8.4 Focus the measuring microscope with a low power objective so that the specimen surface can be observed.

8.5 Adjust the light intensity and adjust the apertures for optimum resolution and contrast.

8.6 Select the area desired for hardness determination. Before applying the force, make a final focus using the measuring objective or the highest magnification objective available.

8.7 Adjust the tester so that the indenter is in the proper place for force application. Select the desired force.

8.8 Activate the tester so that the indenter is automatically lowered and makes contact with the specimen for the normally required time period. Then, remove the force either manually or automatically.

8.9 After the force is removed, switch to the measuring mode, and select the proper objective lens. Focus the image, adjust the light intensity if necessary, and adjust the apertures for maximum resolution and contrast.

8.10 Examine the indentation for its position relative to the desired location and for its symmetry.

8.10.1 If the indentation did not occur at the desired spot, the tester is out of alignment. Consult the manufacturer's instruction manual for the proper procedure to produce alignment. Make another indentation and recheck the indentation location. Readjust and repeat as necessary.

8.10.2 For a Knoop indentation, if one half of the long diagonal is greater than 10 % longer than the other, or if both ends of the indentation are not in sharp focus, the test specimen surface may not be perpendicular to the indenter axis. Check the specimen alignment and make another test.

8.10.3 For a Vickers indentation, if one half of either diagonal is more than 5 % longer than the other half of that diagonal, or if the four corners of the indentation are not in sharp focus, the test surface may not be perpendicular to the indenter axis. Check the specimen alignment and make another test.

8.10.4 If the diagonal legs are unequal as described in 8.10.2 or 8.10.3, rotate the specimen 90° and make another indentation in an untested region. If the nonsymmetrical aspect of the indentations has rotated 90°, then the specimen surface is not

perpendicular to the indenter axis. If the nonsymmetrical nature of the indentation remains in the same orientation, check the indenter for misalignment or damage.

8.10.5 Some materials may have nonsymmetrical indentations even if the indenter and the specimen surface are perfectly aligned. Tests on single crystals or on textured materials may produce such results. When this occurs, check the alignment using a test specimen, such as a standard, known to produce uniformly shaped indentations.

8.10.6 Brittle materials such as ceramics may crack as a result of being indented. Specific details for testing ceramics are contained in Test Methods C 1326 and C 1327.

8.11 Measure the long diagonal of a Knoop indentation, or both diagonals of a Vickers indentation, in accordance with the manufacturer's instruction manual.

8.11.1 Determine the length of the long diagonal of a Knoop indentation or both diagonals of a Vickers indentation to within 0.1 μm (see 6.3). For the Vickers indentations, average the two diagonal length measurements.

8.12 Compute the Knoop or Vickers hardness number using the appropriate equation in Section 3 or Table X6.1 or Table X6.2, respectively. Table X6.1 and Table X6.2 show the Knoop or Vickers hardness for indentations with diagonal lengths from 1 to 200.9 μm using 1 gf. If the force was not 1 gf, multiply the value from Table X6.1 or Table X6.2 by the actual gram-force value to obtain the correct hardness number.

8.13 *Spacing of Indentations*—Generally more than one indentation is made on a test specimen. It is necessary to ensure that the spacing between indentations is large enough so that adjacent tests do not interfere with each other.

8.13.1 For most testing purposes, the minimum recommended spacing between separate tests, and minimum distance between an indentation and the surface of the specimen are illustrated in Fig. 3.

8.13.2 For some applications, closer spacing of indentations than those shown in Fig. 3 may be desired. If closer indentation

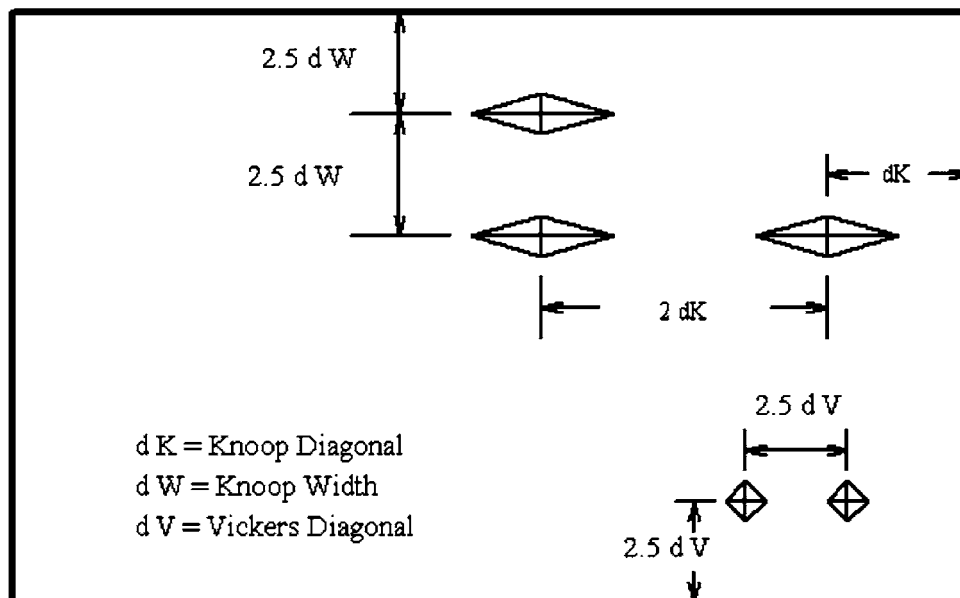

FIG. 3 Minimum Recommended Spacing for Knoop and Vickers Indentations

spacings are used, it shall be the responsibility of the testing laboratory to verify the accuracy of the testing procedure.

9. Report

9.1 Report the following information:

9.1.1 The test results, the number of tests, and, where appropriate, the mean and standard deviation of the tests,

9.1.2 Test force, and

9.1.3 Any unusual conditions encountered during the test.

9.2 The symbols HK for Knoop hardness, and HV for Vickers hardness shall be used with the reported numerical values.

9.2.1 For this standard, the microindentation hardness test results can be reported in several different ways. For example, if the Knoop hardness was found to be 400, and the test force was 100 gf, the test results may be reported as follows:.

9.2.1.1 In the Kilogram force system: 400 HK 0.1.

9.2.1.2 In the gram force system: 400 HK 100 gf.

9.2.1.3 In the SI system: 3.92 GPa.

9.2.2 For nonstandard dwell times, other than 10 to 15 s, the hardness would be reported as 400 HK 0.1 /22 s. In this case, 22 s would be the actual time of full load dwell time.

10. Precision and Bias ³

10.1 The precision and bias of microindentation hardness measurements depend on strict adherence to the stated test procedure and are influenced by instrumental and material factors and indentation measurement errors.

10.2 The consistency of agreement for repeated tests on the same material is dependent on the homogeneity of the material, reproducibility of the hardness tester, and consistent, careful measurement of the indents by a competent operator.

10.3 Instrumental factors that can affect test results include: accuracy of loading; inertia effects; speed of loading; vibrations; the angle of indentation; lateral movement of the indenter or specimen; indentation and indenter shape deviations.

10.3.1 Vibrations during indenting will produce larger indentations with the influence of vibrations becoming larger as the force decreases (1, 2).⁴

10.3.2 The angle between the indenter and specimen surface should be within 2° of perpendicular. Greater amounts of tilting produce nonuniform indentations and invalid test results.

10.4 Material factors that can affect test results include: specimen homogeneity, orientation or texture effects; improper specimen preparation; low specimen surface reflectivity; transparency of the specimen.

10.4.1 Residual deformation from mechanical polishing must be removed, particularly for low-force testing.

10.4.2 Distortion of the indentation shape due to either crystallographic or microstructural texture influences diagonal lengths and the validity of the calculated hardness.

10.4.3 Plastic deformation during indentation can produce ridging around the indentation periphery that will affect diagonal measurement accuracy.

10.4.4 Testing of etched surfaces, depending on the extent of etching, can produce results that are different from those obtained on unetched surfaces (1).

10.5 Measurement errors that can affect test results include: inaccurate calibration of the measuring device; inadequate resolving power of the objective; insufficient magnification; operator bias in sizing the indentations; poor image quality; nonuniform illumination, improper zeroing of the measuring device.

10.5.1 The accuracy of microindentation hardness testing is strongly influenced by the accuracy to which the indentations can be measured.

10.5.2 The error in measuring the diagonals increases as the numerical aperture of the measuring objective decreases (3, 4).

10.5.3 Bias is introduced if the operator consistently under-sizes or oversizes the indentations.

10.6 Some of the factors that affect test results produce systematic errors that influence all test results while others primarily influence low-force test results (5). Some of these problems occur continually, others may occur in an undefined, sporadic manner. Low force hardness tests are influenced by these factors to a greater extent than high force tests.

10.7 For both the Vickers and Knoop hardness tests, the calculated microindentation hardness is a function of three variables: force, indenter geometry and diagonal measurement. Total differentials of the equations used to calculate the microindentation hardness can be used to evaluate the effect variations in these parameters can cause.

10.7.1 *Vickers*—using Eq 6, the total differential for the Vickers hardness number is:

$$dV = \left(\frac{\partial V}{\partial P}\right) dP + \left(\frac{\partial V}{\partial d}\right) dd + \left(\frac{\partial V}{\partial \alpha}\right) d\alpha \quad (10)$$

and

$$\left(\frac{\partial V}{\partial P}\right) = 2 \times 10^3 \times d^{-2} \times \sin\left(\frac{\alpha}{2}\right) \quad (11)$$

$$\left(\frac{\partial V}{\partial d}\right) = -4 \times 10^3 \times P \times d^{-3} \sin\left(\frac{\alpha}{2}\right) \quad (12)$$

$$\left(\frac{\partial V}{\partial \alpha}\right) = 10^3 \times P \times d^{-2} \cos\left(\frac{\alpha}{2}\right) \quad (13)$$

Thus, for a material having a hardness of 500 HV when tested with a 500 gf force, $d = 43.06 \mu\text{m}$, $\alpha = 136^\circ$, and

$$\sin\left(\frac{\alpha}{2}\right) = 0.927184.$$

10.7.1.1 Consider introducing a 1 % error into the hardness of the material through an error in either the applied force, the indenter constant or the measured diagonal length. In this case, the hardness would be $HV' = 505$ or $dV = 5$. Using Eq 11-13, the corresponding errors in the various parameters are as shown in Table 1. Thus a 1 % change in P or a 2.09 % error in α creates a 1 % error in the Vickers hardness number. However, only a 0.5 % error in the measured diagonal is needed to create a 1 % error in Vickers hardness. Furthermore, this

³ Supporting data have been filed at ASTM Headquarters. Request RR:E-04-1004.

⁴ The boldface numbers in parentheses refer to the list of references at the end of this standard.

TABLE 1 Vickers Hardness Analysis—1 % Error

Force, gf	Diagonal, μm	1 % Error		
		ΔP , gm	Δ Diagonal, μm	Δ Angle, $^\circ$
10	6.090	0.100	-0.030	2.836
20	8.612	0.200	-0.043	2.836
50	13.617	0.499	-0.068	2.836
100	19.258	0.999	-0.096	2.836
200	27.235	1.998	-0.136	2.836
500	43.062	4.994	-0.215	2.836
1000	60.899	9.988	-0.304	2.836

2° 50' 24"

analysis indicates that the calculated Vickers hardness number is not strongly influenced by errors in the angle of the indenter.

10.7.2 *Knoop*—Similarly, using Eq 1, it follows that:

$$dK = \left(\frac{\partial K}{\partial P}\right) dP + \left(\frac{\partial K}{\partial c_p}\right) dc_p + \left(\frac{\partial K}{\partial d}\right) dd \quad (14)$$

$$\frac{10^3}{c_p d^2} dP + \frac{10^3 P}{c_p^2 d^2} dc_p + \frac{-2 \times 10^3 P}{c_p d^3} dd \quad (15)$$

and since the indenter has two different angles, A and B,

$$dc_p = \left(\frac{\partial c_p}{\partial A}\right) dA + \left(\frac{\partial c_p}{\partial B}\right) dB \quad (16)$$

$$\left(\frac{\partial c_p}{\partial A}\right) = \frac{-\tan\left(\frac{\angle B}{2}\right)}{4 \sin^2\left(\frac{\angle A}{2}\right)} \quad (17)$$

and

$$\left(\frac{\partial c_p}{\partial B}\right) = \frac{\cot\left(\frac{\angle A}{2}\right)}{4 \cos^2\left(\frac{\angle B}{2}\right)} \quad (18)$$

10.7.2.1 Using the differentials cited in 10.7.2, for the Knoop test at various forces, for a 1 % error in hardness that is, $KH' = 505$ or $dK = 5$, the corresponding errors in the force, diagonal measurement and indenter angle are as shown in Table 2. From this analysis it follows that 1 % error in P creates a 1 % error in HK, 0.5 % error in the measured diagonal creates a 1 % error in HK, and 1 % error in c creates a 1 % error in HK.

10.7.2.2 Since the indenter constant is composed of terms from two different angles, either a 4' 3" error in $\angle A$, or a 26' 20" error in $\angle B$ produces a 1 % error in HK. Unlike the Vickers indenter, the calculated Knoop hardness number is very strongly influenced by small errors in the two angles of

TABLE 2 Knoop Hardness Analysis—1 % Error

Force, gm	Diagonal, μm	ΔP gm	1 % Error		
			Δ diagonal, μm	ΔA , $^\circ$	ΔB , $^\circ$
10	16.87	0.10	-0.08	0.075	0.439
20	23.86	0.20	-0.12	0.075	0.439
50	37.72	0.50	-0.19	0.075	0.439
100	53.35	1.00	-0.27	0.075	0.439
200	75.45	2.00	-0.38	0.075	0.439
500	119.29	5.00	-0.60	0.075	0.439
1000	168.71	10.00	-0.84	0.075	0.439

4' 30" 26' 20"

the indenter. The A angle, 172° 30' 00", is the most sensitive of these parameters. The actual value of c_p for each indenter can be calculated using the certified A and B angles provided by the indenter manufacturer. This will enhance the accuracy of the test measurements.

10.8 An interlaboratory test program was conducted in accordance with Practice E 691 to develop information regarding the precision, repeatability, and reproducibility of the measurement of Knoop and Vickers indentations. The test forces were 25, 50, 100, 200, 500, and 1000 gf on three ferrous and four nonferrous specimens (6, 7). Twelve laboratories measured the indentations, five of each type at each force on each sample. Additional details of this study are given in Appendix X3.

10.8.1 Tests of the three ferrous specimens revealed that nine laboratories produced similar measurements while two laboratories consistently undersized the indentations and one laboratory consistently oversized the indentations. These latter results were most pronounced as the force decreased and specimen hardness increased (that is, as the diagonal size decreased) and were observed for both Vickers and Knoop indentations. Results for the lower hardness nonferrous indentations produced better agreement. However, none of the laboratories that obtained higher or lower results on the ferrous specimens measured the nonferrous indentations.

10.8.2 *Repeatability Interval*—The difference due to test error between two test results in the same laboratory on the same material increases with increasing specimen hardness and with decreasing test force (see X3.4.4).

10.8.3 *Reproducibility Interval*—The difference in test results on the same material tested in different laboratories increased with increasing specimen hardness and with decreasing test force (see X3.4.5).

10.8.4 The within-laboratory and between-laboratory precision values improved as specimen hardness decreased and test force increased. The repeatability interval and reproducibility interval were generally larger than the precision estimate, particularly at low test forces and high specimen hardnesses.

10.8.5 *Image Analysis Measurements*—An interlaboratory test program was conducted in accordance with Practice E 691 to develop information regarding the repeatability and reproducibility of Knoop and Vickers measurements made with automated Image Analysis systems and manual procedures. Four ferrous specimens were used in the round robin. The test were conducted at 100 gf and 300 gf. The participants in the test program measured the same indentations on the four specimens. Seven labs measured the specimens using both procedures. The Knoop indentations on specimen C1 were too long for accurate measurements to be made by one lab; hence, only six sets of measurements were made on this specimen. Near the end of the test program, specimen B1 was lost in shipping; thus only six sets of measurements were made on this specimen. Additional details of the study are contained in Appendix X4.

10.8.6 Repeatability concerns the variability between individual test results obtained within a single laboratory by a single operator with a specific set of test apparatus. For both the manual and automated measurements, the repeatability

interval increased with specimen hardness and decreasing test force, **Appendix X4**. For equivalent testing conditions, the repeatability interval for automated measurements was slightly larger than for manual measurements.

10.8.7 Reproducibility deals with the variability between single test results obtained by different laboratories applying the same test methods to the same or similar test specimens. For both the manual and automated measurements, the reproducibility interval increased with specimen hardness and decreasing test force, **Appendix X4**. For equivalent testing conditions, the reproducibility interval for automated measurements was slightly larger than for manual measurements.

10.8.8 Practice **E 691** nor any other ASTM standard deals with comparing test results of a single property made by two different test methods. Hence it is not possible to statistically and accurately compare the hardness measurements made by the manual and automated procedures. However, this information is graphically represented for comparative purposes, **X4.6**.

11. Conversion to Other Hardness Scales or Tensile Strength Values

11.1 There is no generally accepted method for accurate conversion of Knoop or Vickers microindentation hardness numbers to other hardness scales or tensile strength values. Such conversions are limited in scope and should be used with caution, except for special cases where a reliable basis for the conversion has been obtained by comparison tests. For loads ≥ 100 gf microindentation Vickers hardness numbers are in reasonable agreement with macro Vickers hardness numbers. Refer to Test Method **E 140** for hardness conversion tables for metals.

12. Keywords

12.1 hardness; indentation; Knoop; microindentation; Vickers

ANNEXES

(Mandatory Information)

A1. VERIFICATION OF KNOOP AND VICKERS HARDNESS TESTING MACHINES AND INDENTERS

A1.1 Scope

A1.1.1 **Annex A1** specifies three types of procedures for verifying microindentation (Knoop and Vickers) hardness testing machines: direct verification, indirect verification, and weekly verification. This annex also contains geometric specifications for the indenter.

A1.1.2 Direct verification is a process for verifying that critical components of the hardness testing machine are within allowable tolerances by directly measuring the test forces, indentation measuring system, and testing cycle.

A1.1.3 Indirect verification is a process for periodically verifying the performance of the testing machine by means of standardized test blocks.

A1.1.4 The weekly verification is a process for monitoring the performance of the testing machine between indirect verifications by means of standardized test blocks.

A1.2 General Requirements

A1.2.1 The testing machine shall be verified at specific instances and at periodic intervals as specified in **Table A1.1**, and when circumstances occur that may affect the performance of the testing machine.

A1.2.2 All instruments used to make measurements required by this Annex shall be calibrated traceable to national standards when a system of traceability exists, except as noted otherwise.

A1.2.3 Indirect verification of the testing machine shall be performed at the location where it will be used.

A1.2.4 Direct verification of newly manufactured or rebuilt testing machines may be performed at the place of manufacture, rebuild or the location of use.

TABLE A1.1 Verification Schedule for a Microindentation Hardness Testing Machine

Verification Procedure	Schedule
Direct Verification	When a testing machine is new, or when adjustments, modifications or repairs are made that could affect the application of the test forces or the measuring system. Follow the manufacturers recommendations to determine when a direct verification is needed n a repaired, modified or adjusted instrument. When a testing machine fails an indirect verification.
Indirect Verification	Shall be no longer than every 18 months. Recommended every 12 months. Recommended when a test machine is installed or moved.
Weekly Verification	Required each week that the machine is used. Recommended whenever the indenter or test force is changed.

NOTE A1.1—It is recommended that the calibration agency that is used to conduct the verifications of microindentation hardness testing machines be accredited to the requirements of ISO 17025 (or an equivalent) by a recognized accrediting body that operates to the requirements of ISO Guide 58.

A1.3 Direct Verification

A1.3.1 A direct verification of the testing machine shall be performed at specific instances in accordance with **Table A1.1**. The test forces, indentation measuring system and testing cycle shall be verified as follows.

NOTE A1.2—Direct verification is a useful tool for determining the sources of error in a microindentation hardness testing machine. It is recommended that testing machines undergo direct verification periodically to make certain that errors in one component of the machine are not

being offset by errors in another component.

A1.3.2 Verification of the Test Forces—For each microindentation hardness scale that will be used, the corresponding test force shall be measured. The test forces shall be measured in accordance with ASTM E 4 by means of a Class A elastic force measuring instrument having an accuracy of at least 0.25 %, as described in ASTM E 74.

A1.3.2.1 Make three measurements of each force. The forces shall be measured as they are applied during testing; however, longer dwell times are allowed when necessary to enable the measuring device to obtain accurate measurements.

A1.3.2.2 Each test force F shall meet the requirements specified in **Table A1.2**.

A1.3.3 Verification of the Indentation Measuring System—The measuring device used to determine the diagonal of the indentation shall be verified at five evenly spaced intervals over the working range by comparison with an accurate scale such as a stage micrometer. The line interval accuracy of the stage micrometer shall be 0.1 micron or 0.05 %, which ever is greater. Throughout the range covered, the difference between the reading of the device and of the stage micrometer shall not exceed 0.4 microns or 0.5 %, which ever is greater.

A1.3.4 Verification of the Testing Cycle—The testing machine shall be verified to be capable of meeting the testing cycle tolerances specified in **6.1**. Direct verification of the testing cycle is to be verified by the testing machine manufacturer at the time of manufacture, or when the testing machine is returned to the manufacturer for repair, or when a problem with the testing cycle is suspected. Verification of the testing cycle is recommended but not required as part of the direct verification at other times.

NOTE A1.3—Instruments that have timing controlled by software or other nonadjustable components do not have to be verified providing that the design has been proven to produce the correct time cycles.

A1.3.5 Verification of Indenter—The geometry of the indenter is verified at time of manufacturing and it is mandatory for new machines. Subsequent verifications of the indenter are performed by visual inspection of the resulting indentation; it is sufficient to verify the absence of defects from the shape of indentations performed on test blocks. The indenter Geometry is specified as follows:

A1.3.5.1 Vickers Microindentation Indenter:

(1) The Vickers microindentation indenter for standard use, direct verification, and indirect verification shall have face angles of $136^{\circ} 0' \pm 30'$.

(2) The offset shall not exceed 0.5 μm .

(3) The four faces of the diamond shall be equally inclined to the axis of the indenter to within $\pm 30'$, as shown in **Fig. 2**. Vickers microindentation diamond indenters used for calibrating test blocks shall have face angles of $136^{\circ} 0' \pm 6'$.

NOTE A1.4—It is permissible to verify the offset by using a microscope with at least 500 \times magnification to view an indent created by the indenter

and compare the offset length to a known dimension.

A1.3.5.2 Knoop Indenter:

(1) The ideal Knoop diamond indenter has an included longitudinal edge angle, $\angle A = 172^{\circ} 30'$, and included transverse edge angle, $\angle B = 130^{\circ} 0'$. The ideal indenter constant, $c_p = 0.07028$. For all indenters, c_p shall be within $\pm 1\%$ of the ideal value, $0.06958 \leq c_p \leq 0.07098$.

(2) The tolerance of $\angle A = 172^{\circ} 30'$, shall be $\pm 0.10^{\circ} 6'$.

(3) The corresponding $\angle B = 130^{\circ}$ must be contained within the dimensions listed in **Table A1.3** and graphically as described by **Fig. A1.1**.

(4) The offset shall not be more than 1 μm in length for indentations greater than 15 μm in length, as shown in **Fig. 1**. For shorter indentations the offset should be proportionally less.

(5) The four faces of the diamond shall be equally inclined to the axis of the indenter to within $\pm 30'$, as shown in **Fig. 1**.

(6) The device used to verify the indenter shall have a max. uncertainty of ± 40 minutes.

A1.3.6 Direct Verification Failure—If any of the direct verifications fail the specified requirements, the testing machine shall not be used until it is adjusted or repaired. If the test forces, indentation measuring system or testing cycle may have been affected by an adjustment or repair, the affected components shall be verified again by a direct verification.

A1.4 Indirect Verification

A1.4.1 An indirect verification of the testing machine shall be performed in accordance with the schedule given in **Table A1.1**. Indirect verifications may be required more frequently than stated in **Table A1.1** and should be based on the usage of the testing machine.

A1.4.2 The testing machine shall be verified for each test force and for each indenter that will be used prior to the next indirect verification. Hardness tests made using microindentation hardness scales that have not been verified within the schedule given in **Table A1.1** do not meet this standard.

A1.4.3 Standardized test blocks used for the indirect verification shall meet the requirements of **Annex A2**.

NOTE A1.5—It is recognized that appropriate standardized test blocks are not available for all geometric shapes, materials, or hardness ranges.

A1.4.4 The indenter(s) to be used for the indirect verification shall meet the requirements of **A1.3.5**.

A1.4.5 As-found Condition—It is recommended that the as-found condition of the testing machine be assessed as part of an indirect verification. This is important for documenting the historical performance of the machine. This procedure should be conducted by the verification agency prior to any cleaning, maintenance, adjustments, or repairs.

A1.4.5.1 The as-found condition of the testing machine shall be determined with the user's indenter that is normally

TABLE A1.2 Accuracy of Applied Forces

Applied Force, gf	Accuracy, %
$P < 200$	1.5
$P \geq 200$	1.0

TABLE A1.3 Angular Tolerances for Knoop Indenters

A Angle, °	B Angle, °	
	Minimum	Maximum
172.4	128.97	129.85
172.6	130.15	131.02

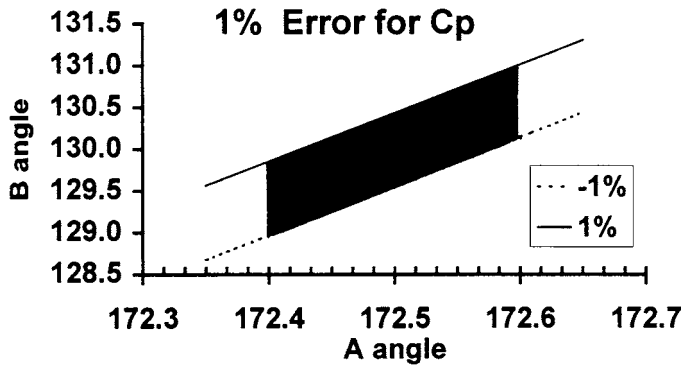

FIG. A1.1 Schematic Representing the Acceptable Regions of Knoop Indenter Angles

TABLE A1.5 Repeatability of Test Machines—Indirect Verification by Standardized Test Blocks Based on Measured Diagonal Lengths^A

Hardness Range of Standardized Test Blocks		Force, gf	R Maximum Repeatability (%)	E Maximum Error (%)
Knoop	Vickers			
HK < 100	HV < 100	1 ≤ P ≤ 500	13	3
100 ≤ HK ≤ 250	100 ≤ HV ≤ 240	1 ≤ P < 500	13	2
250 < HK ≤ 650	240 < HV ≤ 600		5	2
HK > 650	HV > 600		4	2
100 ≤ HK ≤ 250	100 ≤ HV ≤ 240	500 ≤ P ≤ 1000	8	2
250 < HK ≤ 650	240 < HV ≤ 600		4	2
HK > 650	HV > 600		3	2

^A In all cases, the repeatability is the greater of the percentage given or 1 µm; the maximum error is the greater of the value obtained or 0.5 µm.

used with the testing machine. One or more standardized test blocks in the range of normal testing should be used for each microindentation hardness scale that will undergo indirect verification.

A1.4.5.2 On each standardized test block, make at least three measurements distributed uniformly over the test surface. Let d_1, d_2, \dots, d_n be the indentation diagonal measurement values, and \bar{d} be the average of the measurements.

NOTE A1.6—When testing at low forces it may be necessary to increase the number of tests in order to obtain more consistent results.

A1.4.5.3 Determine the repeatability R and the error E in the performance of the testing machine for each standardized test block that is measured using Eq A1.1 and Eq A1.3 in section A1.7.

A1.4.5.4 The repeatability R and the error E should be within the tolerances of Table A1.5.

A1.4.5.5 If the calculated values of the repeatability R or the error E fall outside the specified tolerances, this is an indication that the hardness tests made since the last indirect verification may be suspect.

A1.4.6 *Cleaning and Maintenance*—Perform cleaning and routine maintenance of the testing machine when required in accordance with the manufacturer’s specifications and instructions.

A1.4.7 *Indirect Verification Procedure*—The indirect verification procedure is designed to verify that for all of the microindentation hardness scales to be used, each test force is being accurately applied, each indenter is correct, and the measuring device is calibrated correctly for the range of indentation sizes that these scales produce. This is accomplished by making microindentation hardness measurements on test blocks that have been calibrated for appropriate microindentation hardness scales that employ each of the corresponding test forces.

A1.4.7.1 The testing machine shall be verified with the user’s indenter(s) normally used for testing.

TABLE A1.4 Hardness Ranges Used for Indirect Verification

Range	Knoop	Vickers
Low	< 250	< 240
Medium	250–650	240–600
High	> 650	> 600

A1.4.7.2 A minimum of two standardized test blocks shall be used for the verification of the testing machine. The hardness values and microindentation hardness scales of the test blocks shall be chosen such that the following criteria are met:

A1.4.7.3 Each test force will be used.

A1.4.7.4 At least one microindentation hardness test block calibrated according to Annex A2, shall be used for each scale to be verified.

A1.4.7.5 At least two of the blocks shall be from different hardness ranges, low, mid or high hardness as specified in Table A1.4.

A1.4.7.6 The highest test force shall be verified on a block from the lower of the chosen hardness ranges to produce the largest indentation size, and the lowest test force shall be used on the block from the higher of the chosen hardness ranges to produce the smallest indentation size. The two extremes of indentation size will verify the capability of the measuring device.

Example 1—A testing machine is to be verified for the HV0.5 and HK1 scales. Two test blocks are chosen for the verification: 150 HV0.5 (low-range) and 450 HK1 (mid-range). In this case, both of the test forces are verified by using only two blocks. The highest test force (1000 gf) is used on a low-range hardness block, and the lowest test force (500 gf) is used on a mid-range test block, which is the higher of the two hardness ranges.

Example 2—A testing machine is to be verified for the HK0.1, HV 0.3 and HV1 scales. Three test blocks are chosen for the verification: 180 HK0.1 (low-range), 480 HV0.3 (mid-range) and 720 HV1 (high-range). In this case, there are three test forces that must be verified. The highest test force (1000 gf) is used on a low-range hardness block, and the lowest test force (100 gf) scale is used on the high-range test block. The middle test force (300 gf) scale could be used on either a low-range or mid-range test block.

A1.4.7.7 On each standardized test block, make five measurements distributed uniformly over the test surface. Let d_1, d_2, \dots, d_5 be the five indentation diagonal measurement values, and be the average of the five measurements. Determine the repeatability R and the error E in the performance of the testing

machine using Eq A1.1 and Eq A1.3 in section A1.7, for each hardness level of each microindentation hardness scale to be verified. The repeatability R and the error E shall be within the tolerances of Table A1.5.

A1.4.7.8 If the measurements of error E or repeatability R using the user's indenter fall outside of the specified tolerances, the indirect verification measurements may be repeated using a different indenter.

A1.4.7.9 The indirect verification shall be approved only when the testing machine measurements of repeatability and error meet the specified tolerances with the user's indenter.

A1.4.8 In cases where it is necessary to replace the indenter during the period between indirect verifications, the new indenter must be verified for use with the specific testing machine. The user shall perform the verification by following the as-found procedures given in A1.4.5. If the repeatability, R , and error, E , values fall within the tolerances in Table A1.5 the indenter can be used.

A1.4.9 When the combination of block hardness and test force produces indentations with diagonals less than 20 μm long, indirect verification using standardized test blocks is not recommended. In these situations, the indentation measurement error represents a significant proportion of the diagonal length. This can lead to substantial deviations in hardness from the stated value. Examples of these errors are contained in Section 10 and Tables 1 and 2.

A1.5 Weekly Verification

A1.5.1 The weekly verification is intended as a tool for the user to monitor the performance of the testing machine between indirect verifications. At a minimum, the weekly verification shall be performed in accordance with the schedule given in Table A1.1 for each microindentation hardness scale that will be used. It is strongly recommended that this verification should be performed on a daily basis.

A1.5.2 It is recommended that the weekly verification procedures be performed whenever the indenter or test force is changed.

A1.5.3 *Weekly Verification Procedures*—The procedures to use when performing a weekly verification are as follows.

A1.5.3.1 At least one standardized test block that meets the requirements of Annex A2 shall be used for each microindentation hardness scale to be used. When test blocks are commercially available, the hardness level of the test blocks shall be chosen at approximately the same hardness value as the material to be measured.

A1.5.3.2 The indenter to be used for the weekly verification shall be the indenter that is normally used for testing.

A1.5.3.3 Before performing the weekly verification tests, ensure that the testing machine is working freely, the stage and test block are clean, and the measuring device is properly adjusted and zeroed.

A1.5.3.4 Make at least three hardness measurements on each of the verification test blocks. The tests shall be distributed uniformly over the surface of the test blocks.

A1.5.3.5 Let \bar{d} be the average of the measurements. Determine the error E in the performance of the testing machine using Eq A1.3 for each standardized test block that is measured.

A1.5.3.6 If the error E calculated for each test block is within the tolerances given in Table A1.5, the testing machine with the indenter may be regarded as performing satisfactorily.

A1.5.3.7 If the error E calculated for any of the test blocks is outside the tolerances, the weekly verification may be repeated with a different indenter. If the average of the hardness measurements again falls outside of tolerances for any of the test blocks, an indirect verification shall be performed.

A1.5.3.8 Whenever a testing machine fails a weekly verification, the hardness tests made since the last valid weekly verification may be suspect.

NOTE A1.7—It is highly recommended that the results obtained from the weekly verification testing be recorded using accepted Statistical Process Control techniques, such as, but not limited to, \bar{X} -bar (measurement averages) and R -charts (measurement ranges), and histograms.

A1.6 Verification Report

A1.6.1 A verification report is required for direct and indirect verifications. A verification report is not required for a weekly verification.

A1.6.2 The verification report shall be produced by the person performing the verification and include the following information when available as a result of the verification performed.

A1.6.2.1 Reference to this ASTM test method.

A1.6.2.2 Method of verification.

A1.6.2.3 Identification of the hardness testing machine and the indenters used.

A1.6.2.4 Means of verification (test blocks, elastic proving devices, etc.) with statements defining traceability to a national standard.

A1.6.2.5 The microindentation hardness scale(s) verified.

A1.6.2.6 The individual or calculated results used to determine whether the testing machine meets the requirements of the verification performed. Measurements made to determine the as-found condition of the testing machine shall be included whenever they are made.

A1.6.2.7 Description of adjustments or maintenance done to the testing machine.

A1.6.2.8 Date of verification and reference to the verifying agency or department.

A1.6.2.9 Signature of the person performing the verification.

A1.7 Example Calculations of Repeatability and Error

A1.7.1 *Repeatability of Microindentation Hardness Tester:*

A1.7.1.1 Repeatability, R , of the tester (%) is calculated by the following equation:

$$R = 100 \left(\frac{d_{\max} - d_{\min}}{\bar{d}} \right) \quad (\text{A1.1})$$

where d_{\max} is the longest of the five diagonals (or mean diagonals), d_{\min} is the shortest of the five diagonals, and \bar{d} is the

mean diagonal length. The repeatability is acceptable if it meets the requirements given in **Table A1.5**.

A1.7.1.2 The following is an example of a repeatability calculation. Assume that five Knoop indentations were made on a test block with a nominal hardness of 404 HK at the certified block test force of 300 gf and that the five readings are $d_1 = 103.9$, $d_2 = 104.8$, $d_3 = 102.3$, $d_4 = 102.8$ and $d_5 = 100.2$ μm , respectively. Therefore, $d_{\text{max}} - d_{\text{min}} = 104.8 - 100.2 = 4.6$ μm and $R = 100(4.6)/102.8 = 4.47$ %. According to **Table A1.3**, the repeatability for a test block with a hardness >250 to 650 HK should be <5 %. In this example, the tester met the repeatability requirement for this hardness test block and force. However, if these diagonals had been obtained using a test block with a nominal hardness of 700 HK and a certified test force of 500 gf, then the repeatability would be inadequate as **Table A1.3** requires $R < 4$ % for a hardness >650 HK.

A1.7.2 *Error of Microindentation Hardness Tester:*

A1.7.2.1 The error, E , of the machine is:

$$E = \bar{d} - d_s \quad (\text{A1.2})$$

The percent error, $\%E$, is calculated by the following equation:

$$\%E = 100 \left(\frac{\bar{d} - d_s}{d_s} \right) \quad (\text{A1.3})$$

where \bar{d} is the measured mean diagonal length and d_s is the reported certified mean diagonal length, μm .

A1.7.2.2 The error between the certified mean diagonal and the measured mean diagonal shall not exceed the tolerances in **Table A1.5**, or ± 0.5 μm , whichever is greater.

A1.7.2.3 The following is an example of an error calculation based on the data given in **A1.4.5.2**, and a certified mean diagonal length for the test block, d_s , of 100.8 μm (420 HK300gf). Since $\bar{d} = 102.8$ μm , $(\bar{d} - d_s) = 102.8 - 100.8 = 2.0$ μm . Thus, $E = 1.98$ %. In this case, the percent error meets the maximum of ± 2 %, which is greater than ± 0.5 μm . For this example, $\bar{d} - d_s$ must be $> \pm 2.016$ μm for the error to be above the limit of ± 2 %.

A2. CALIBRATION OF STANDARDIZED HARDNESS TEST BLOCKS FOR MICROINDENTATION HARDNESS TEST MACHINES

A2.1 Scope

A2.1.1 This annex describes the calibration of standardized hardness test blocks used to verify microindentation hardness test machines. The standardizing machine shall meet the direct verification method described in **A1.3**.

A2.2 Test Block Manufacture

A2.2.1 The test block thickness shall be greater than twenty times the depth of the indentation made with the certified test force.

A2.2.2 The test block material and manufacturing processes shall be chosen to produce the required degree of homogeneity, structural stability and uniformity of hardness at the prepared surface.

A2.2.3 Ferromagnetic test blocks shall be demagnetized by the manufacturer and shall be maintained in that condition by the user.

A2.2.4 The test block support surface shall have a finely ground surface finish. The maximum deviation from flatness of the test and support surfaces shall not exceed 5 μm . The maximum error in parallelism shall not exceed 15 μm in 30 mm.

A2.2.5 The test block test surface shall be polished according to the procedures in **Methods E 3** to yield the true microstructure, free from scratches that would interfere with production of the impression or measurement of the impression diagonal(s). The mean, centerline average, surface roughness height measurement of the test surface shall not exceed 0.1 μm (4 $\mu\text{in.}$).

A2.2.6 Repolishing of the test block will invalidate the standardization and is not recommended. Cleaning of the polished test block surface is often required in normal usage but must not alter the hardness or quality of the polished test surface.

A2.3 Standardizing Tester Requirements

A2.3.1 The standardizing tester shall comply with Annex A1 with the following additional requirements:

A2.3.2 Direct verifications shall be performed every 12 months.

A2.3.3 The Vickers indenter shall have the following angles and tolerances (see **Fig. 2**).

A2.3.3.1 The face angles shall be $136^\circ 0 \pm 6'$.

A2.3.3.2 The face angles shall be equally inclined to the axis of the indenter within $\pm 15'$.

A2.3.3.3 The offset should not exceed 0.3 μm , see **Note A1.4**.

A2.3.4 The Knoop indenter shall have an indenter constant of 0.07028 ± 0.5 %. The offset should not exceed 0.5 μm , see **Note A1.4**.

A2.3.5 The test force application time shall be between 5 and 7 seconds. The test force dwell time shall be between 13 and 15 seconds.

A2.3.6 The indent measuring system shall be verified according to **A1.3.3**. The difference between the reading device and the stage micrometer shall not exceed 0.2 μ or 0.25 %, which ever is greater.

A2.3.7 Indirect verifications shall be performed using NIST SRM test blocks whenever they are available.

A2.4 Test Block Standardization Procedure

A2.4.1 Certification of the hardness test blocks shall be performed with a microindentation hardness test machine that has been verified by the direct method. Direct verification of this machine must be performed at least once every 12 months, as described in A1.3.5.

A2.4.2 Test Cycle:

A2.4.2.1 The time from the first contact between the indenter and the test specimen until the full test force is applied shall be within 5 and 7 s.

A2.4.2.2 The full test force shall be applied from 13 to 15 s.

A2.4.3 Make five groups of impressions, each containing five impressions, where one group is in the center of each of the four quadrants of the block and the fifth group is in the center of the test block.

A2.4.4 Adjust the illumination for the measuring system to produce uniform intensity over the field of view and optimum contrast between the impressions and the block surface (see 6.4.1, 6.4.2, and Appendix X1).

A2.4.5 Measure the Knoop diagonal length, or average Vickers diagonal length of each of the twenty-five impressions. Record the data by group and by block. It is recommended that each indentation be measured by two observers (compare test results by rater).

A2.5 Repeatability of the Standardized Test Block

A2.5.1 Calculate the mean and standard deviation of the diagonals, or average diagonals, for the five indentations in each of the five groups.

A2.5.2 The repeatability, R , of the impression size and, therefore, of the hardness, is calculated in the manner described in A1.4.5.5 by Eq A1.1. Calculate the mean of all 25 measured diagonals, or average diagonals, \bar{d} , and determine d_{\max} and d_{\min} , the longest and shortest of the 25 measurements, respectively. R is a measure of the hardness homogeneity of the test block, although R is influenced by all of the variables that affect the repeatability of microindentation test results.

A2.5.3 Table A2.1 lists the required maximum R values for test blocks by indenter type, test force range and hardness range. The measured R value must be less than these limits for it to be considered sufficiently uniform enough in hardness to function as a standardized test block.

A2.6 Marking

A2.6.1 The test surface of each block shall be permanently marked with the thickness of the block, an appropriate identifying serial number, the name or mark of the supplier or an identification mark.

A2.6.2 When the test blocks are encapsulated in a mounting medium, the information contained in A2.6.1 shall be permanently placed on the surface of the medium that contains the test surface. The reported thickness shall be the thickness of the mounting medium, not the thickness of the encapsulated block.

A2.7 Certification of Standardized Test Block

A2.7.1 The certificate accompanying each standardized hardness test block shall include the following information: The arithmetic mean of each group of five impression diagonals; the arithmetic mean and standard deviation of all twenty-five impression diagonals, the corresponding hardness value, the test force, serial number of the test block, name of the manufacturer and certifying organization, magnification used, and the date.

TABLE A2.1 Repeatability of Diagonal Measurements for Standardized Test Block Certification^A

Hardness Range of Standardized Test Blocks		Force, gf	R , %, Less Than
Knoop	Vickers		
$100 \leq HK \leq 250$	$100 \leq HV \leq 240$	$1 \leq P < 500$	12
$250 < HK \leq 650$	$240 < HV \leq 600$		4
$HK > 650$	$HV > 600$		3
$100 \leq HK \leq 250$	$100 \leq HV \leq 240$	$500 \leq P \leq 1000$	7
$250 < HK \leq 650$	$240 < HV \leq 600$		3
$HK > 650$	$HV > 600$		2

^A In all cases, the repeatability limit is the greater of the percentage given or 1 μm .

APPENDIXES

(Nonmandatory Information)

X1. ADJUSTMENT OF KÖHLER ILLUMINATION SYSTEMS

X1.1 While some optical systems are permanently aligned, others have means for minor adjustments. To gain the utmost in resolution, the operator should make the following adjustments:

X1.1.1 Focus the surface of a flat polished specimen to critical sharpness.

X1.1.2 Center the illumination source.

X1.1.3 Centrally align field and aperture diaphragms.

X1.1.4 Open the field diaphragm so that it just disappears from the field of view.

X1.1.5 Remove the eyepiece and examine the rear focal plane of the objective. If all the components are in their proper

places, the source of illumination and the aperture diaphragm will appear in sharp focus.

X1.1.6 Full-aperture diaphragm is preferred for maximum resolving power. If glare is excessive, reduce the aperture, but never use less than the $\frac{3}{4}$ opening since resolution would be decreased and diffraction phenomena could lead to false measurements.

X1.1.7 If the light is too strong for eye comfort, reduce the intensity by the use of an appropriate neutral density filter or rheostat control.

X2. CORRELATION OF MICROINDENTATION HARDNESS TEST DATA BETWEEN LABORATORIES

X2.1 Scope

X2.1.1 This procedure provides guidance in the comparison of microindentation hardness test data from two or more laboratories.

X2.2 Correlation Procedure

X2.2.1 All laboratories shall first establish that their test equipment conforms to the requirements in Test Method **E 384**.

X2.2.2 The specimens shall be taken from adjoining areas of the larger specimen prior to being sent to the cooperating laboratories for specimen preparation and testing.

X2.2.3 The specimens shall be prepared for microindentation hardness by two or more laboratories using essentially the same procedures. If the specimens are capable of being prepared as metallographic specimens, established ASTM procedures shall be maintained uniformly among the laboratories as follows:

X2.2.3.1 The same surfaces shall be exposed for the micro-indentation hardness test. This is to ensure that grain direction, if a characteristic, is taken into consideration.

X2.2.3.2 The surface preparation of the specimens shall be in accordance with Methods E 3.

X2.2.4 All laboratories shall calibrate the optics of their test apparatus using a stage micrometer in accordance with **A1.3.3**.

X2.2.5 The indentations shall be oriented the same way relative to grain direction in order to avoid differences in results arising from this factor.

X2.2.6 The method of measuring the indentations shall be established prior to making the tests. It shall be the most accurate method as described by the equipment manufacturer.

X2.2.7 A minimum number of indentations shall be established. This shall conform to acceptable statistical methods of analysis, in accordance with Practice **E 122**.

X2.2.8 Each test specimen shall be indented and measured by the laboratory having prepared it, then sent with the data for testing in the other laboratory or laboratories.

X2.2.8.1 After the specimens have been exchanged, each laboratory shall measure and record the indentations applied by the originating laboratory in a manner identical to the initial measurements.

X2.2.8.2 Each laboratory shall then repeat the indentation and measuring procedures, as performed in **X2.2.5** and **X2.2.6**, before sending the data and specimen to the remaining laboratory or laboratories.

X2.2.8.3 Each laboratory shall determine a set of micro-indentation hardness values from the specimen they prepared, as well as sets of values they obtained by indenting and measuring specimens prepared by the other laboratory or laboratories.

X2.2.9 All data shall then be analyzed by the same acceptable statistical methods to establish the limits of agreement that are attainable between the two laboratories. As a minimum, the following statistical data shall be evolved:

X2.2.9.1 Mean, \bar{X} ,

X2.2.9.2 Standard deviation, σ , and

X2.2.9.3 Standard error of the mean, σ/\bar{X} .

X2.3 Referee

X2.3.1 If the laboratories cannot establish an acceptable correlation through this procedure, it will be necessary to introduce an independent laboratory to act as the referee.

X3. RESULTS OF INTERLABORATORY TEST OF THE MEASUREMENT OF MICROINDENTATIONS

X3.1 Introduction

X3.1.1 This interlaboratory test program was conducted to develop precision and bias estimates for the measurement of both Knoop and Vickers indentations using forces of 25 to 1000 gf for ferrous and nonferrous specimens covering a wide range of hardness.

X3.2 Scope

X3.2.1 This interlaboratory test program provides information on the measurement of the same indentations by different laboratories according to the procedures of Practice **E 691**.

X3.3 Procedure

X3.3.1 Five indentations were made under controlled conditions at each force (25, 50, 100, 200, 500, and 1000 gf), with both Knoop and Vickers indenters using three ferrous and four nonferrous specimens.

X3.3.2 Twelve laboratories measured the indentations on the ferrous specimens and the nonferrous specimens. Two laboratories measured the hardnesses of both groups.

X3.3.3 Each laboratory used the same stage micrometer to calibrate their measuring device.

X3.3.4 Results were tabulated and analyzed in accordance with Practice E 691.

X3.4 Results

X3.4.1 For the three ferrous specimens, results from nine laboratories showed general agreement as to the diagonal sizes. Two other laboratories consistently undersized the indentations (higher hardness) and one laboratory consistently oversized the indentations (lower hardness). This bias was observed with both Vickers and Knoop indentations sized by these laboratories with the degree of bias increasing as the indentation size decreased and the specimen hardness increased. Test on the four nonferrous specimens produced general agreement, but none of the three laboratories that produced biased results for the ferrous specimens measured the nonferrous specimens.

X3.4.2 For the Vickers test data, the calculated hardness increased with increasing force and then became reasonably constant. This trend was apparent in the data from the nine consistent laboratories (ferrous specimens) and for the laboratory that oversized the indentations. The two laboratories that consistently undersized the Vickers indentations exhibited substantial data scatter for the tests with forces of less than 100 gf. However for higher forces, their indentation measurements were relatively constant. The force at which the hardness became relatively constant increased with increasing specimen hardness. For specimens below about 300 HV, there was relatively little difference in HV over the test force range.

X3.4.3 For the Knoop test data, most of the laboratories agreed that the hardness decreased continually with increasing test force and then became reasonably constant. However, the two laboratories that exhibited outlier data for the ferrous specimens did show the opposite trend; this is quite unusual. The difference in HK values between low forces and high forces increased with increasing specimen hardness. For specimens with hardnesses below about 300 HK, the difference in hardness was quite small over the test force range.

X3.4.4 *Repeatability Interval*—The difference due to test error between two test results in the laboratory on the same material was calculated using the $(S_r)_j$ values, the pooled within-laboratory standard deviation. $(S_r)_j$ increased with diagonal size and the relationship varied for each material and test type. Table X3.1 lists regression equations that show the relationship between $(S_r)_j$ and the diagonal length, μm . The repeatability interval $I_r(j)$, was calculated based on the relationships in Table X3.1. Because the repeatability intervals are also a function of diagonal length, regression equations were also calculated, Table X3.2. The repeatability intervals, in terms of Knoop and Vickers values for ferrous and nonferrous specimens, are shown in Figs. X3.1-X3.4.

X3.4.5 *Reproducibility Interval*—The difference in test results on the same material in different laboratories was calculated using the $(S_R)_j$ values, the between-laboratory estimate of precision. $(S_R)_j$ increased with diagonal size and the relationship varied for each material and test type. Table X3.3 lists the regression equations that show the relationship between $(S_R)_j$ and the diagonal length, μm . The reproducibility intervals $(I_R)_j$, were calculated based on the relationships shown in Table X3.3. Because the reproducibility intervals are also a function of diagonal length, regression equations were also calculated, Table X3.4. The reproducibility intervals, in terms of Knoop and Vickers values for the ferrous and nonferrous specimens, are shown in Figs. X3.1-X3.4.

X3.4.6 The within-laboratory and between-laboratory precision values were calculated from $(V_r(\%))_j$ and $(V_L(\%))_j$ which are the coefficients of variation for within-laboratory and between-laboratory tests. Both are a function of the length of the diagonal. The within-laboratory and between-laboratory precision values were relatively similar for both Vickers and Knoop test data, either ferrous or nonferrous. In general, the repeatability intervals and reproducibility intervals were larger than the precision estimates, particularly at low test forces and high specimen hardnesses.

TABLE X3.1 Relationship Between Diagonal Length and $(S_r)_j$, the Pooled Within-Laboratory Standard Deviation

Material	Test	Regression Equation	Correlation Coefficient
Ferrous	Vickers	$(S_r)_j = 0.231 + 0.00284 \bar{d}_1$	0.535
Ferrous	Knoop	$(S_r)_j = 0.216 + 0.006 \bar{d}_1$	0.823
Nonferrous	Vickers	$(S_r)_j = 0.373 + 0.008 \bar{d}_1$	0.862
Nonferrous	Knoop	$(S_r)_j = 0.057 + 0.0177 \bar{d}_1$	0.8196

TABLE X3.2 Relationship Between the Diagonal Length and $(I_r)_j$, the Repeatability Interval

Material	Test	Regression Equation
Ferrous	Vickers	$(I_r)_j = 0.653 + 0.008 \bar{d}_1$
Ferrous	Knoop	$(I_r)_j = 0.614 + 0.017 \bar{d}_1$
Nonferrous	Vickers	$(I_r)_j = 1.0556 + 0.0226 \bar{d}_1$
Nonferrous	Knoop	$(I_r)_j = 0.161 + 0.05 \bar{d}_1$

TABLE X3.3 Relationship Between Diagonal Length and $(S_R)_j$, the Between-Laboratory Estimate of Precision

Material	Test	Regression Equation	Correlation Coefficient
Ferrous	Vickers	$(S_R)_j = 0.31 + 0.004 \bar{d}_1$	0.747
Ferrous	Knoop	$(S_R)_j = 0.333 + 0.007 \bar{d}_1$	0.899
Nonferrous	Vickers	$(S_R)_j = 0.357 + 0.0156 \bar{d}_1$	0.8906
Nonferrous	Knoop	$(S_R)_j = 0.378 + 0.0177 \bar{d}_1$	0.8616

TABLE X3.4 Relationship Between the Diagonal Length and $(I_R)_j$, the Repeatability Interval

Material	Test	Regression Equation
Ferrous	Vickers	$(I_R)_j = 0.877 + 0.0113 \bar{d}_1$
Ferrous	Knoop	$(I_R)_j = 0.946 + 0.0198 \bar{d}_1$
Nonferrous	Vickers	$(I_R)_j = 1.0103 + 0.0441 \bar{d}_1$
Nonferrous	Knoop	$(I_R)_j = 1.07 + 0.05 \bar{d}_1$

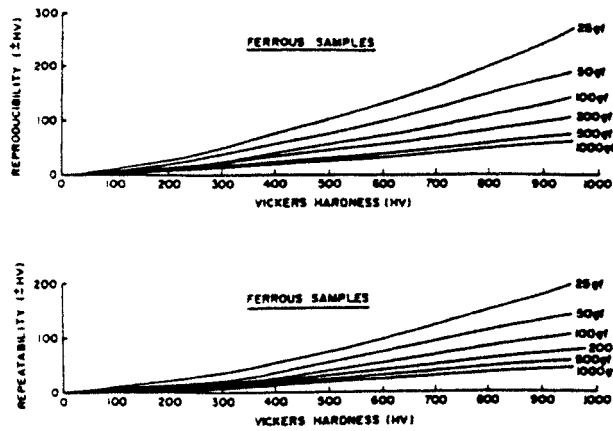

FIG. X3.1 Repeatability and Reproducibility Intervals in Terms of Vickers Hardness (\pm) for the Ferrous Samples as a Function of Test Load and Specimen Hardness

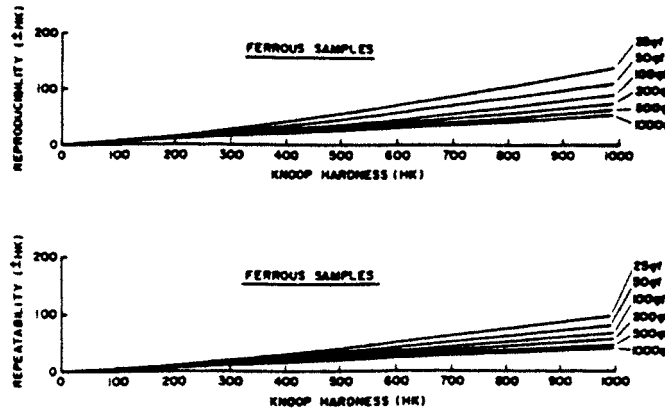

FIG. X3.2 Repeatability and Reproducibility Intervals in Terms of Knoop Hardness (\pm) for the Ferrous Samples as a Function of Test Load and Specimen Hardness

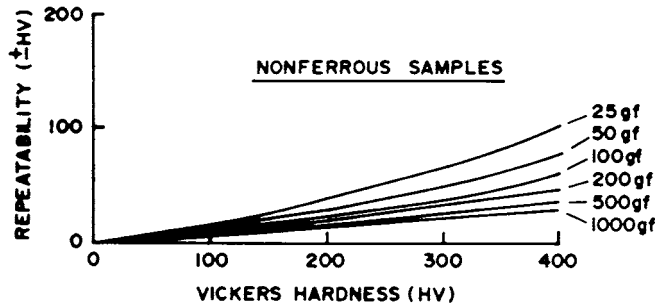
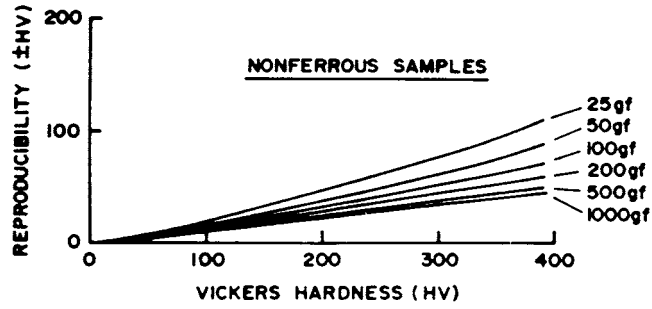

FIG. X3.3 Repeatability and Reproducibility Intervals in Terms of Vickers Hardness (\pm) for the Nonferrous Samples as a Function of Test Load and Specimen Hardness

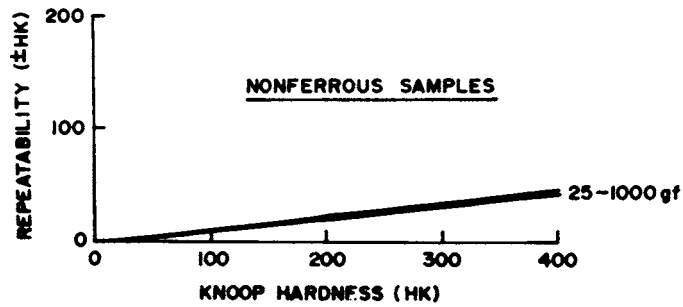
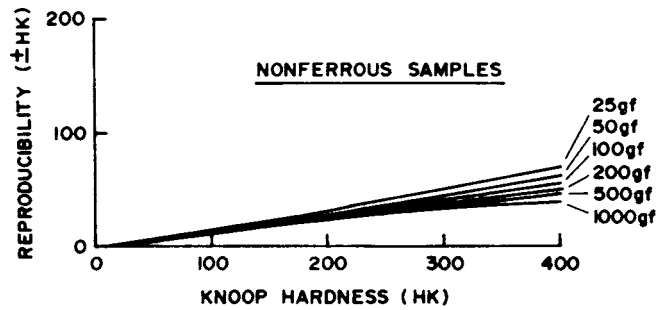

FIG. X3.4 Repeatability and Reproducibility Intervals in Terms of Knoop Hardness (\pm) for the Nonferrous Samples as a Function of Test Load and Specimen Hardness

X4. RESULTS OF AN INTERLABORATORY TEST COMPARING MICROINDENTATION HARDNESS TESTING USING MANUAL AND AUTOMATED MEASURING SYSTEMS

X4.1 Introduction

X4.1.1 An interlaboratory test program was conducted to develop information comparing Knoop and Vickers microindentation hardness tests made with Automated Image Analysis systems and manual procedures. Four ferrous specimens were used in the test program.

X4.2 Scope

X4.2.1 This interlaboratory test program provides information on measurements of the same indentations made by different laboratories using two different measuring methods according to the procedures of Practice E 691.

X4.3 Procedure

X4.3.1 The test were conducted under controlled conditions using loads of 100 gf and 300 gf. Ten Knoop and ten Vickers indentations were made for each load, a total of 40 indentations. The participants in the test program measured the same indentations on the four specimens. Seven laboratories measured the specimens using both procedures. The results of these seven sets of measurements were used for the analysis. The Knoop indentations on specimen C1 were too long for accurate measurements to be made by one lab; hence, only six sets of measurements were made on this specimen. Near the end of the test program, specimen B1 was lost in shipping; thus only six sets of measurements were made on this specimen.

X4.4 Repeatability

X4.4.1 Repeatability concerns the variability between individual test results obtained within a single laboratory by a

single operator with a specific set of test apparatus. For both the manual and automated measurements, the repeatability interval increased with specimen hardness and decreasing test force, Tables X4.1-X4.4, and Figs. X4.1-X4.4. For equivalent testing conditions, the repeatability interval for automated measurements was slightly larger than for manual measurements.

X4.5 Reproducibility

X4.5.1 Reproducibility deals with the variability between single test results obtained by different laboratories applying the same test methods to the same or similar test specimens. For both the manual and automated measurements, the reproducibility interval increased with specimen hardness and decreasing test force, Tables X4.1-X4.4, and Figs. X4.1-X4.4. For equivalent testing conditions, the reproducibility interval for automated measurements was slightly larger than for manual measurements.

X4.6 Comparisons

X4.6.1 Practice E 691 nor any other ASTM standard deals with comparing test results of a single property made by two different test methods. Hence it is not possible to statistically and accurately compare the hardness measurements made by the manual and automated procedures. However, this information is graphically represented for comparative purposes, Figs. X4.5-X4.8.

TABLE X4.1 Precision Statistics for Manual and Automated Knoop Tests at 100 gf Load

Manual							
Spec.	Labs	Mean	Sx	Sr	SR	r	R
C1	7	228.62	6.88	9.30	11.18	26.03	31.32
D1	7	344.80	10.54	9.80	14.06	27.44	39.36
A2	7	491.48	28.67	14.87	31.95	41.63	89.45
B1	6	901.67	62.40	21.17	65.55	59.28	183.55
Automated							
Spec.	Labs	Mean	Sx	Sr	SR	r	R
C1	7	232.07	7.29	9.54	11.62	26.72	32.55
D1	7	348.97	10.74	9.54	14.04	26.70	39.32
A2	7	510.13	30.35	19.53	35.56	54.69	99.56
B1	6	914.72	57.82	29.22	64.13	81.83	179.56

TABLE X4.2 Precision Statistics for Manual and Automated Knoop Tests at 300 gf Load

Manual							
Spec.	Labs	Mean	Sx	Sr	SR	r	R
C1	6	215.81	5.49	7.66	9.10	21.44	25.49
D1	7	330.64	6.99	7.49	9.97	20.98	27.92
A2	7	466.95	17.99	11.45	21.02	32.06	58.85
B1	6	827.47	20.41	16.13	25.51	45.16	71.43
Automated							
Spec.	Labs	Mean	Sx	Sr	SR	r	R
C1	6	217.82	5.73	6.87	8.68	19.24	24.31
D1	7	335.76	12.23	8.22	14.50	23.03	40.61
A2	7	476.97	23.46	10.56	25.51	29.58	71.44
B1	6	821.00	24.62	10.89	26.70	30.50	74.76

TABLE X4.3 Precision Statistics for Manual and Automated Vickers Tests at 100 gf Load

Manual							
Spec.	Labs	Mean	Sx	Sr	SR	r	R
C1	7	205.31	6.36	6.82	9.07	19.10	25.40
D1	7	299.52	6.07	7.65	9.46	21.43	26.50
A2	7	482.76	21.58	12.29	24.53	34.42	68.69
B1	6	821.56	46.01	24.02	51.35	67.25	143.77
Automated							
Spec.	Labs	Mean	Sx	Sr	SR	r	R
C1	7	203.30	6.94	6.47	9.27	18.12	25.95
D1	7	299.78	14.36	5.23	15.19	14.63	42.54
A2	7	482.86	32.07	16.50	35.69	46.19	99.93
B1	6	808.17	47.72	21.30	51.82	59.63	145.09

TABLE X4.4 Precision Statistics for Manual and Automated Vickers Tests at 300 gf Load

Manual							
Spec.	Labs	Mean	Sx	Sr	SR	r	R
C1	7	197.07	3.40	5.32	6.09	14.91	17.06
D1	7	298.91	5.47	7.38	8.89	20.68	24.89
A2	7	474.58	18.00	12.45	21.53	34.86	60.28
B1	6	810.60	29.67	16.50	33.55	46.21	93.94
Automated							
Spec.	Labs	Mean	Sx	Sr	SR	r	R
C1	7	196.37	6.44	5.57	8.33	15.60	23.32
D1	7	297.88	10.42	6.69	12.20	18.72	34.15
A2	7	483.72	18.96	12.30	22.26	34.44	62.34
B1	6	809.55	20.55	11.60	23.31	32.49	65.27

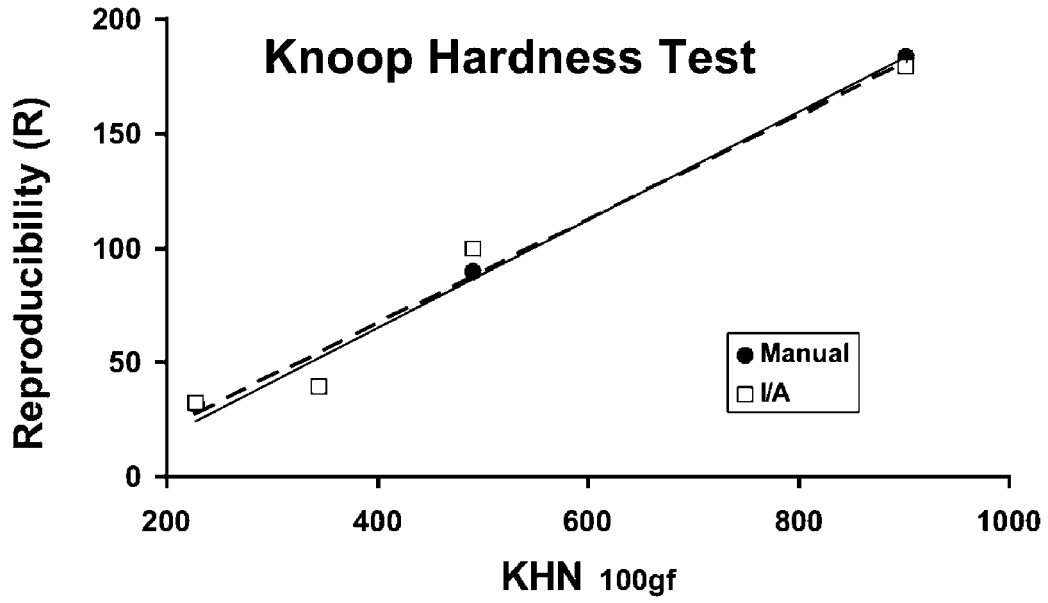

FIG. X4.1 Reproducibility of the Knoop 100 gf Manual and Automated Microindentation Hardness Tests

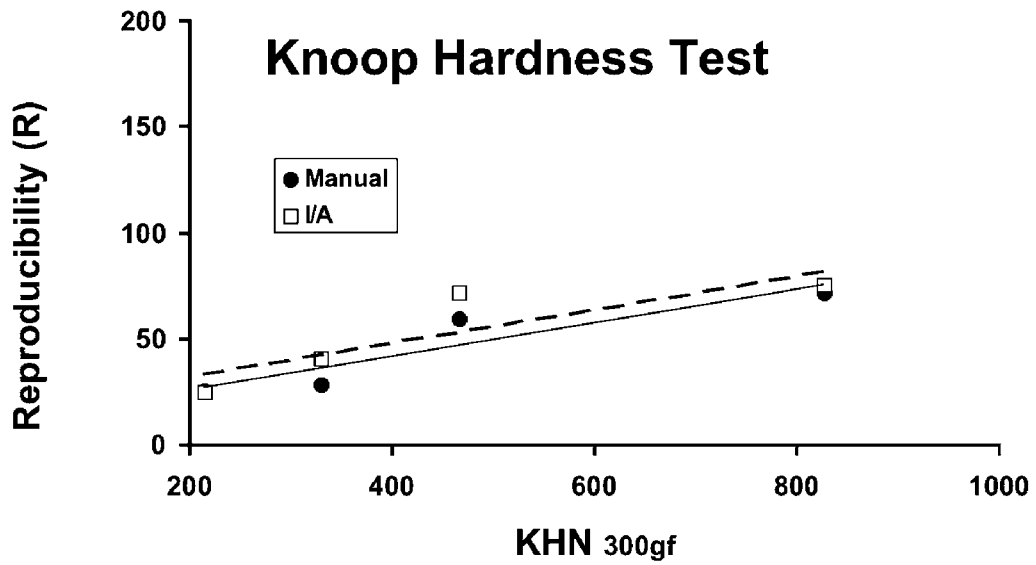

FIG. X4.2 Reproducibility of the Knoop 300 gf Manual and Automated Microindentation Hardness Tests

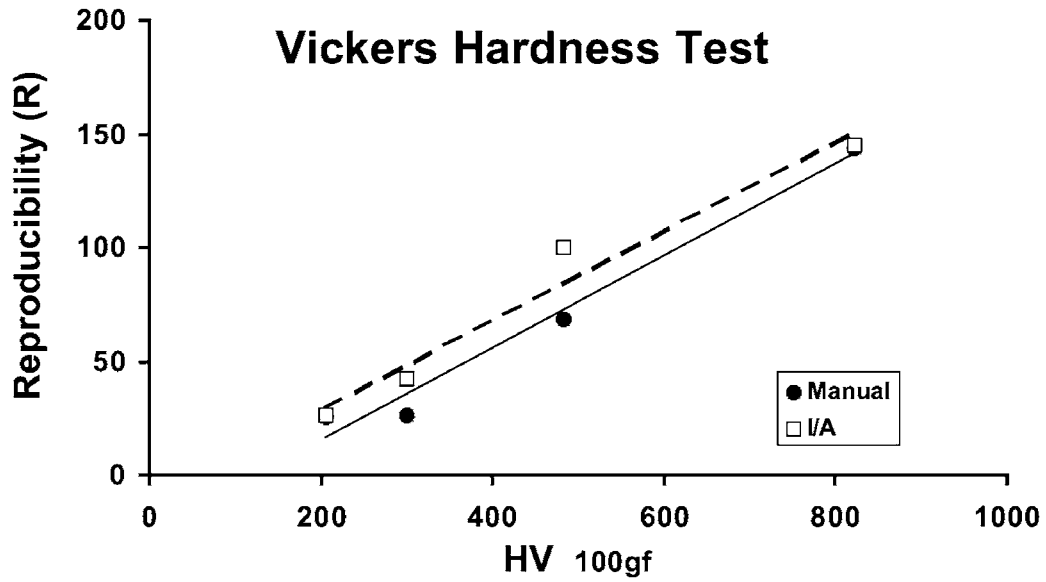

FIG. X4.3 Reproducibility of the Vickers 100 gf Manual and Automated Microindentation Hardness Tests

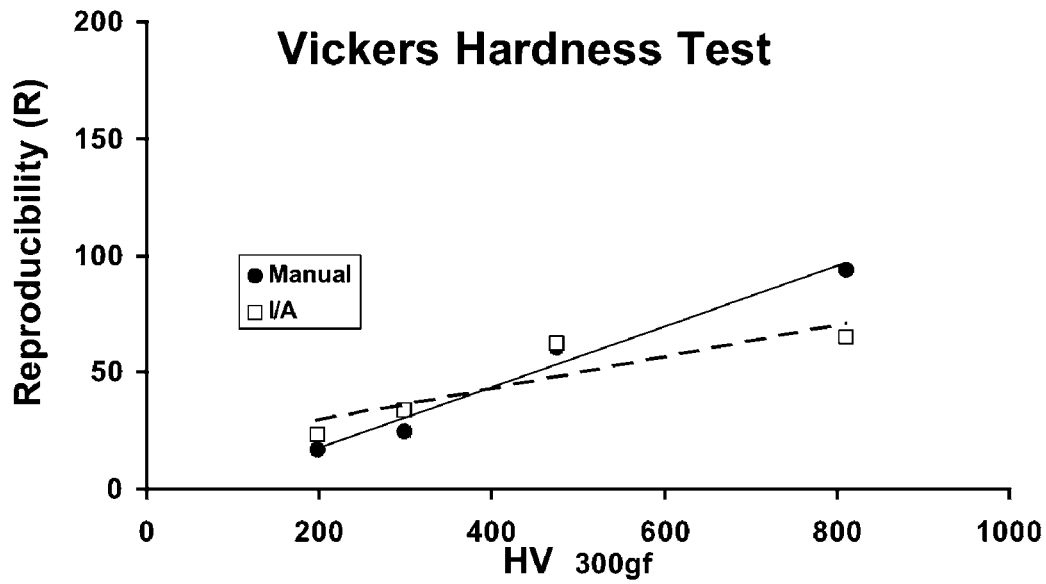

FIG. X4.4 Reproducibility of the Vickers 300 gf Manual and Automated Microindentation Hardness Tests

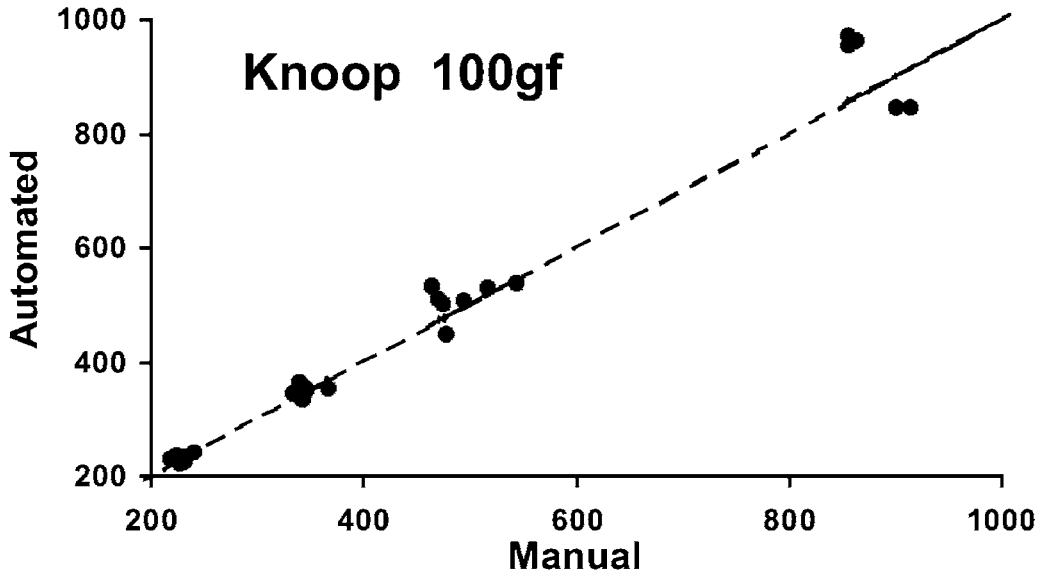

FIG. X4.5 Comparison between Knoop 100 gf Manual and Automated Microindentation Hardness Tests

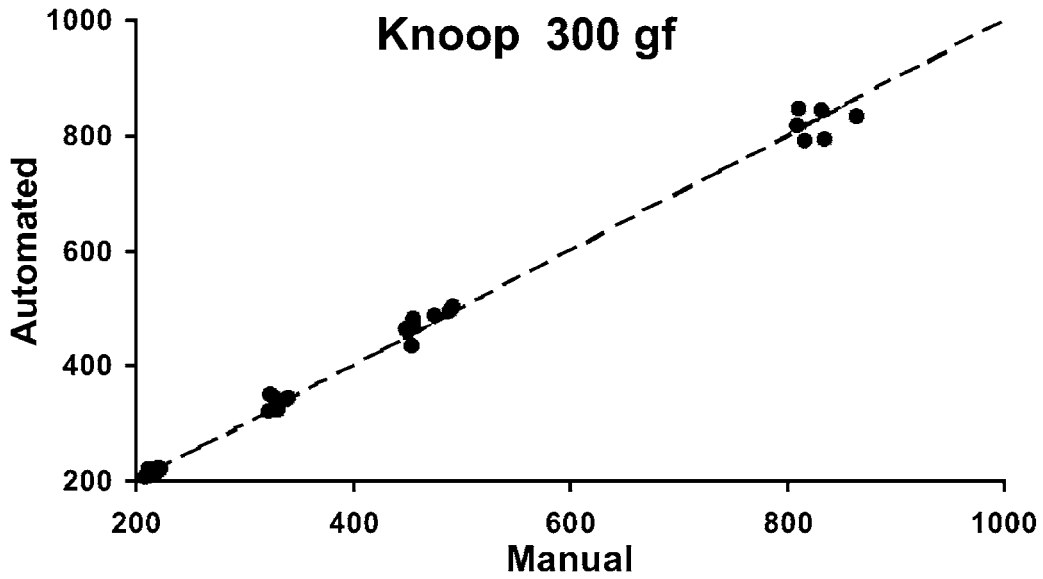

FIG. X4.6 Comparison between Knoop 300 gf Manual and Automated Microindentation Hardness Tests

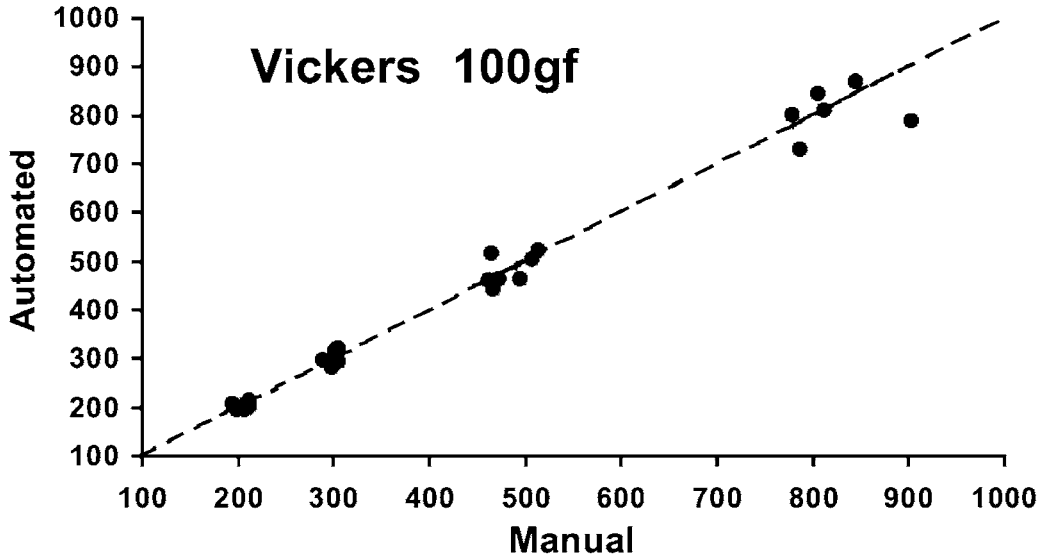

FIG. X4.7 Comparison between Vickers 100 gf Manual and Automated Microindentation Hardness Tests

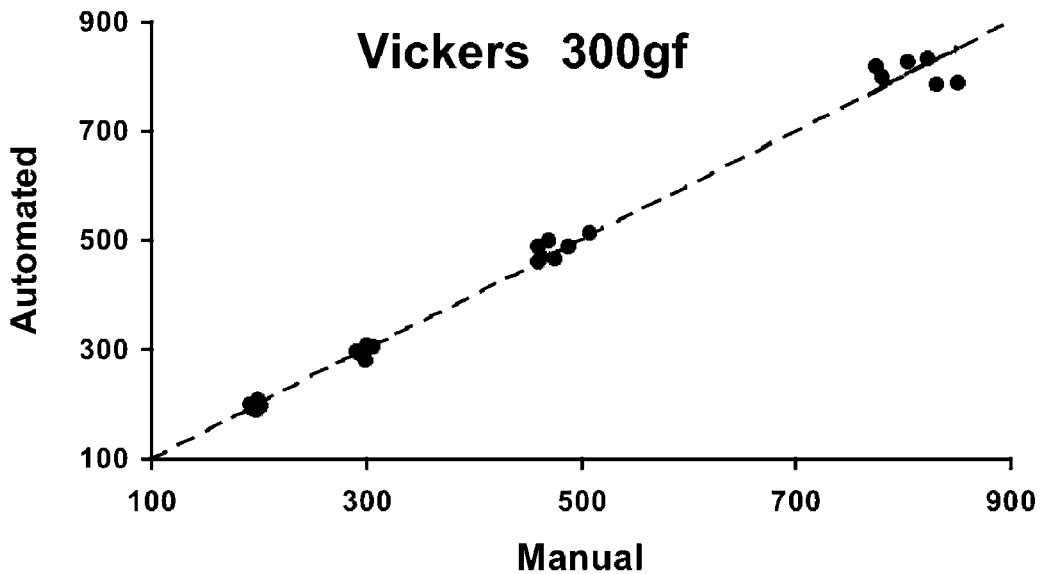

FIG. X4.8 Comparison between Vickers 300 gf Manual and Automated Microindentation Hardness Tests

X5. RECOMMENDATIONS FOR LIGHT FORCE MICROINDENTATION HARDNESS TESTING

X5.1 Introduction

X5.1.1 Microindentation hardness of materials can be determined using a variety of loads to force the indenter into the test piece. Testing is considered to be light force when the force in use produces indentations with a diagonal length of less than 20 μm. Both Knoop and Vickers hardness numbers increase in proportion to the inverse of the square of the indentation diagonal length, Eq 2 and 7. Thus, hardness numbers obtained from indentations with diagonals measuring less than 20 μm are much more sensitive to variations of a few tenths of a micrometre in the actual or measured length of the diagonals than hardness numbers obtained by measuring larger indenta-

tions, Eq 12 and 16. Creation of valid indentations, and the accurate measurement of their diagonals, becomes even more imperative as the indentations become smaller. For example, consider a material with a Vickers hardness of 500, Table 1. For a force of 100 gf, the diagonal length would be 19.258 μm. To maintain an error of ± 1%, the accuracy of the diagonal measurement must be ≤ 0.096 μm. Similarly for a material with a Knoop hardness of 500, when tested with a 20 gf force, the ideal diagonal length would be 23.86 μm, Table 2. To maintain an error of ± 1%, the accuracy of the diagonal measurement has to be ≤ 0.12 μm. Measurements to this level of accuracy are impossible to achieve by optical microscopy.

Because of the inherent difficulties involved in obtaining and measuring indentations with diagonals less than 20 μm , and the increasing effect of possible indentation or measurement errors, light force microindentation hardness testing requires precautions in addition to those normally necessary. Small indentations may be due to high test piece hardness or the use of light forces. In either case, some of the concerns involved with obtaining accurate hardness results are addressed in this appendix.

X5.2 Scope

X5.2.1 These recommendations provide guidance and suggest additional precautions for microindentation hardness testing when the measured diagonals of indentations are less than 20 μm .

X5.3 Environment:

X5.3.1 Vibration:

X5.3.1.1 Vibration of the microindentation hardness tester during a light force test can cause a large percentage increase in the measured diagonals. Reasonable accuracy and precision can only be achieved when the test instrument is isolated from vibration as much as possible during testing. Use of an isolation table or isolation platform is mandatory. Airborne vibrations in the vicinity of the test instrument, such as air currents and loud noises, are to be avoided.

X5.3.1.2 It is recommended that test instruments not be located above the ground floor of the building due to the increase in vibration usually experienced by the upper floors. Test instruments should be located in areas away from machinery that may cause low (<20 Hz) frequency vibrations, since low frequencies are more easily transmitted through isolation tables and platforms.

X5.3.2 *Level*—Microindentation hardness testers must be level in order to obtain usable information. Errors due to minor unleveling become more important as the forces become lighter.

X5.3.3 *Temperature*—Control of the temperature of the specimen, testing instrumentation, and surrounding area should be considered. It is recommended that these temperatures be maintained at $23 \pm 3^\circ\text{C}$. As the length of the measured diagonal becomes smaller, it may be necessary to increase control of temperature to reduce variability.

X5.4 Specimens

X5.4.1 Specimen Preparation:

X5.4.1.1 Usually, test pieces require mounting. Care must be taken to ensure that the specimens are well supported in the mounting material, and that the surface to be tested can be placed into the test instrument such that it will be normal to both the loading and optical axes.

X5.4.1.2 The surface properties of the test specimen must not be altered due to specimen preparation. Metallographic polishing, when applicable, should be performed using accepted techniques known to minimize the deformed layer remaining on the surface of the specimen. Light etching followed by light repolishing may be used to further decrease the thickness of any deformed layer. Electropolishing can

provide surfaces essentially free of deformation due to preparation. Areas to be tested must appear flat in the field of focus of the microscope used to measure the diagonals of the indentations.

X5.4.1.3 The surfaces to be tested should be as clean as possible. Care must be taken to avoid surface contaminants that may be absorbed into the surfaces of some materials such as polymers or ceramics.

X5.4.2 *Microstructure of Specimen*—If the microstructure of the material test piece is on the same size scale as the indentation diagonal length, an increase in the variability of the hardness data should be expected. Indentations placed within a single grain will experience resistance to deformation somewhat dependent on the orientation of that grain to the test surface. Since these orientations are normally random, variability of results is increased. Indentation diagonal lengths can vary depending upon the number of grain boundaries transversed by the indentation. Multiphase material systems will provide indentation diagonal lengths that may be proportional to the volume percentage of each phase included within the volume of deformation caused by the indentation. In the above cases, an increase in the number of measurements taken will be necessary to provide meaningful results.

X5.5 Instruments

X5.5.1 *Magnification of Microscope*—Classic microindentation hardness testers make use of optics that provide magnifications of up to 800X. Higher magnifications are recommended when performing light force testing. Specimens may be removed from the test instrument following the indentation operation, and the diagonals of the indentations measured using a separate high quality light (or SEM measurements, see 4.7.1) microscope capable of providing higher magnifications.

X5.5.2 *Optical Quality of Microscope*—Use of highly corrected objectives with numerical apertures of 0.9 or greater is recommended. Use of dark field illumination or differential interference contrast may improve the contrast of the image and also enhance the users ability to detect the ends of the indentations.

X5.5.3 *Diagonal Measuring Device*—The measurement technique and the devices used to perform the measurements should be capable of discerning differences in length of 0.1 μm or less. In some cases, it may be preferable to obtain a photomicrograph of the indentation first, and measure the length of the diagonal as seen in the photomicrograph. In all cases, calibration of magnifications and measuring devices is necessary.

X5.5.4 *Accuracy of Forces*—Often, small indentation diagonal lengths are the result of the use of very light forces, in many cases less than 10 g. Force accuracy of $\pm 1\%$ is required in accordance with A3.2. For light forces, this requires that no oils, dust, or other minor contaminants be present. For example, when using a force of 2.0 g, contaminants with a total mass of more than 0.02 g render the results of the test invalid, Eq 11.

X5.5.5 *Loading Rates*—When using light forces, the impact of the indenter on the surface of the test piece can cause significant inaccuracies to occur. Use of the slowest loading rate available for each instrument is recommended.

X5.5.6 Indenters—Greater repeatability, accuracy, and precision may be obtained by the careful selection of indenters. Verification of the included angles of the faces, the degree of mismatch at the vertex, and the sharpness of the edges are appropriate criteria for the selection of indenters. Using the manufacturer’s certification, the exact indenter constant should be calculated and used to minimize errors, Eq 13, Eq 17 and Eq 18.

X5.6 Measurement of Indentations

X5.6.1 Indentations that do not appear symmetrical should not be considered valid for diagonal measurement. A difference in symmetry greater than 10 % should be addressed with concern. If consistently asymmetrical indentations are obtained, the alignment of the specimen to the indenter should be adjusted. If the problem persists, the microindentation hardness instrument should be serviced by a qualified technician.

X5.7 Scanning Electron Microscope

X5.7.1 Measurement of indentation diagonals using a scanning electron microscope is possible. However, careful cali-

bration of the SEM photographic image at the exact magnification to be used is essential. For these measurements, the specimen should be perpendicular to the beam, that is, the tilt angle should be 0°. The accelerating voltage, and other parameters should remain as they were for calibration. (The SEM should be calibrated in both the X and Y directions; refer to Practice E 766. Indentations to be measured should not extend to the periphery of the SEM field of view, as the video signal can be distorted at the edges of the video monitor.

X5.8 Video and Automatic Measuring Systems

X5.8.1 Typical video or computerized measuring systems lack the necessary resolution for obtaining acceptable results when indentation diagonal lengths are less than 20 µm. Loss of resolution within the digitized image can cause a substantial decrease in the accuracy of the measurement. Extremely high resolution video cameras and monitors, when appropriately assembled into a measuring system, may be capable of resolution sufficient to provide accurate results.

X6. HK AND HV VALUES FOR A 1 gf TEST LOAD

X6.1 Refer to **Table X6.1** for the Knoop hardness numbers for load of 1 gf. Refer to **Table X6.2** for the Vickers hardness numbers for load of 1 gf.

TABLE X6.1 Knoop Hardness Numbers for Load of 1 gf

Diagonal of Impression, µm	Knoop Hardness Number for Diagonal Measured to 0.1 µm									
	0.0	0.1	0.2	0.3	0.4	0.5	0.6	0.7	0.8	0.9
1	14230	11760	9881	8420	7260	6324	5558	4924	4392	3942
2	3557	3227	2940	2690	2470	2277	2105	1952	1815	1692
3	1581	1481	1390	1307	1231	1162	1098	1039	985.4	935.5
4	889.3	846.5	806.6	769.5	735.0	702.7	672.4	644.1	617.6	592.6
5	569.2	547.1	526.2	506.2	488.0	470.4	453.7	437.9	423.0	408.8
6	395.2	382.4	370.2	358.5	347.4	336.8	326.7	317.0	307.7	298.9
7	290.4	282.3	274.5	267.0	259.8	253.0	246.3	240.0	233.9	228.0
8	222.3	216.9	211.6	206.5	201.7	196.9	192.4	188.0	183.7	179.6
9	175.7	171.8	168.1	164.5	161.0	157.7	154.4	151.2	148.2	145.2
10	142.3	139.5	136.8	134.1	131.6	129.1	126.6	124.3	122.0	119.8
11	117.6	115.5	113.4	111.4	109.5	107.6	105.7	103.9	102.2	100.5
12	98.81	97.19	95.60	94.05	92.54	91.07	89.63	88.22	86.85	85.51
13	84.20	82.91	81.66	80.44	79.24	78.07	76.93	75.81	74.72	73.65
14	72.60	71.57	70.57	69.58	68.62	67.68	66.75	65.85	64.96	64.09
15	63.24	62.40	61.59	60.78	60.00	59.23	58.47	57.73	57.00	56.28
16	55.58	54.89	54.22	53.55	52.90	52.26	51.64	51.02	50.41	49.82
17	49.24	48.66	48.10	47.54	47.00	46.46	45.94	45.42	44.91	44.41
18	43.92	43.43	42.96	42.49	42.03	41.57	41.13	40.69	40.26	39.83
19	39.42	39.00	38.60	38.20	37.81	37.42	37.04	36.66	36.29	35.93
20	35.57	35.22	34.87	34.53	34.19	33.86	33.53	33.21	32.89	32.57
21	32.27	31.96	31.66	31.36	31.07	30.78	30.50	30.22	29.94	29.67
22	29.40	29.13	28.87	28.61	28.36	28.11	27.86	27.61	27.37	27.13
23	26.90	26.67	26.44	26.21	25.99	25.77	25.55	25.33	25.12	24.91
24	24.70	24.50	24.30	24.10	23.90	23.71	23.51	23.32	23.14	22.95
25	22.77	22.59	22.41	22.23	22.05	21.88	21.71	21.54	21.38	21.21
26	21.05	20.89	20.73	20.57	20.42	20.26	20.11	19.96	19.81	19.66
27	19.52	19.37	19.23	19.09	18.95	18.82	18.68	18.54	18.41	18.28

TABLE X6.1 *Continued*

Diagonal of Impression, μm	Knoop Hardness Number for Diagonal Measured to 0.1 μm									
	0.0	0.1	0.2	0.3	0.4	0.5	0.6	0.7	0.8	0.9
28	18.15	18.02	17.23	17.77	17.64	17.52	17.40	17.27	17.15	17.04
29	16.92	16.80	16.89	16.57	16.46	16.35	16.24	16.13	16.01	15.92
30	15.81	15.71	15.60	15.60	15.40	15.30	15.20	15.10	15.00	14.90
31	14.81	14.71	14.62	14.52	14.43	14.34	14.25	14.16	14.07	13.98
32	13.90	13.81	13.72	13.64	13.55	13.47	13.39	13.31	13.23	13.15
33	13.07	12.99	12.91	12.83	12.75	12.68	12.60	12.53	12.45	12.38
34	12.31	12.24	12.17	12.09	12.02	11.95	11.89	11.82	11.75	11.68
35	11.62	11.55	11.48	11.42	11.35	11.29	11.23	11.16	11.10	11.04
36	10.98	10.92	10.86	10.80	10.74	10.68	10.62	10.56	10.51	10.45
37	10.39	10.34	10.28	10.23	10.17	10.12	10.06	10.01	9.958	9.906
38	9.854	9.802	9.751	9.700	9.650	9.600	9.550	9.501	9.452	9.403
39	9.355	9.307	9.260	9.213	9.166	9.120	9.074	9.028	8.983	8.938
40	8.893	8.849	8.805	8.761	8.718	8.675	8.632	8.590	8.548	8.506
41	8.465	8.423	8.383	8.342	8.302	8.262	8.222	8.183	8.144	8.105
42	8.066	8.028	7.990	7.952	7.915	7.878	7.841	7.804	7.768	7.731
43	7.695	7.660	7.624	7.589	7.554	7.520	7.485	7.451	7.417	7.383
44	7.350	7.316	7.283	7.250	7.218	7.185	7.153	7.121	7.090	7.058
45	7.027	6.996	6.965	6.934	6.903	6.873	6.843	6.813	6.783	6.754
46	6.724	6.695	6.666	6.638	6.609	6.581	6.552	6.524	6.497	6.469
47	6.441	6.414	6.387	6.360	6.333	6.306	6.280	6.254	6.228	6.202
48	6.176	6.150	6.125	6.099	6.074	6.049	6.024	6.000	5.975	5.951
49	5.926	5.902	5.878	5.854	5.831	5.807	5.784	5.761	5.737	5.714
50	5.692	5.669	5.646	5.624	5.602	5.579	5.557	5.536	5.514	5.492
51	5.471	5.449	5.428	5.407	5.386	5.365	5.344	5.323	5.303	5.282
52	5.262	5.242	5.222	5.202	5.182	5.162	5.143	5.123	5.104	5.085
53	5.065	5.046	5.027	5.009	4.990	4.971	4.953	4.934	4.916	4.898
54	4.880	4.082	4.844	4.826	4.808	4.790	4.773	4.756	4.738	4.721
55	4.704	4.687	4.670	4.653	4.636	4.619	4.603	4.586	4.570	4.554
56	4.537	4.521	4.505	4.489	4.473	4.457	4.442	4.426	4.410	4.395
57	4.379	4.364	4.349	4.334	4.319	4.304	4.289	4.274	4.259	4.244
58	4.230	4.215	4.201	4.188	4.172	4.158	4.144	4.129	4.115	4.102
59	4.088	4.074	4.060	4.046	4.033	4.019	4.006	3.992	3.979	3.966
60	3.952	3.939	3.926	3.913	3.900	3.887	3.875	3.862	3.849	3.837
61	3.824	3.811	3.799	3.787	3.774	3.762	3.750	3.738	3.726	3.714
62	3.702	3.690	3.678	3.666	3.654	3.643	3.631	3.619	3.608	3.596
63	3.585	3.574	3.562	3.551	3.540	3.529	3.518	3.507	3.496	3.485
64	3.474	3.463	3.452	3.442	3.431	3.420	3.410	3.399	3.389	3.378
65	3.368	3.357	3.347	3.337	3.327	3.317	3.306	3.296	3.286	3.276
66	3.267	3.257	3.247	3.237	3.227	3.218	3.208	3.198	3.189	3.179
67	3.170	3.160	3.151	3.142	3.132	3.123	3.114	3.105	3.095 [†]	3.086
68	3.077	3.068	3.059	3.050	3.041	3.032	3.024	3.015	3.006	2.997
69	2.989	2.980	2.971	2.963	2.954	2.946	2.937	2.929	2.921	2.912
70	2.904	2.896	2.887	2.879	2.871	2.863	2.855	2.846	2.839	2.831
71	2.823	2.815	2.807	2.799	2.791	2.783	2.776	2.768	2.760	2.752
72	2.745	2.737	2.730	2.722	2.715	2.707	2.700	2.692	2.685	2.677
73	2.670	2.663	2.656	2.648	2.641	2.634	2.627	2.620	2.613	2.605
74	2.598	2.591	2.584	2.577	2.571	2.564	2.557	2.550	2.543	2.536
75	2.530	2.523	2.516	2.509	2.503	2.496	2.490	2.483	2.476	2.470
76	2.463	2.457	2.451	2.444	2.438	2.431	2.425	2.419	2.412	2.406
77	2.400	2.394	2.387	2.381	2.375	2.369	2.363	2.357	2.351	2.345
78	2.339	2.333	2.327	2.321	2.315	2.309	2.303	2.297	2.292	2.286
79	2.280	2.274	2.268	2.263	2.257	2.251	2.246	2.240	2.234	2.229
80	2.223	2.218	2.212	2.207	2.201	2.196	2.190	2.185	2.179	2.174
81	2.169	2.163	2.158	2.153	2.147	2.142	2.137	2.132	2.127	2.121
82	2.116	2.111	2.106	2.101	2.096	2.091	2.086	2.080	2.075	2.070
83	2.065	2.060	2.056	2.051	2.046	2.041	2.036	2.031	2.026	2.021
84	2.017	2.012	2.007	2.002	1.998	1.993	1.988	1.983	1.979	1.974
85	1.969	1.965	1.960	1.956	1.951	1.946	1.942	1.937	1.933	1.928
86	1.924	1.919	1.915	1.911	1.906	1.902	1.897	1.893	1.889	1.884
87	1.880	1.876	1.871	1.867	1.863	1.858	1.854	1.850	1.846	1.842
88	1.837	1.833	1.829	1.825	1.821	1.817	1.813	1.809	1.804	1.800

TABLE X6.1 *Continued*

Diagonal of Impression, μm	Knoop Hardness Number for Diagonal Measured to 0.1 μm									
	0.0	0.1	0.2	0.3	0.4	0.5	0.6	0.7	0.8	0.9
89	1.796	1.792	1.788	1.784	1.780	1.776	1.772	1.768	1.765	1.761
90	1.757	1.753	1.749	1.745	1.741	1.737	1.733	1.730	1.726	1.722
91	1.718	1.715	1.711	1.707	1.703	1.700	1.696	1.692	1.688	1.685
92	1.681	1.677	1.674	1.670	1.667	1.663	1.659	1.656	1.652	1.649
93	1.654	1.642	1.638	1.635	1.631	1.628	1.624	1.621	1.617	1.614
94	1.610	1.607	1.604	1.600	1.597	1.593	1.590	1.587	1.583	1.580
95	1.577	1.573	1.570	1.567	1.563	1.560	1.557	1.554	1.550	1.547
96	1.544	1.541	1.538	1.534	1.531	1.528	1.525	1.522	1.519	1.515
97	1.512	1.509	1.506	1.503	1.500	1.497	1.494	1.491	1.488	1.485
98	1.482	1.479	1.476	1.473	1.470	1.467	1.464	1.461	1.458	1.455
99	1.452	1.449	1.446	1.443	1.440	1.437	1.434	1.431	1.429	1.426
100	1.423	1.420	1.417	1.413	1.412	1.409	1.406	1.403	1.400	1.398
101	1.395	1.392	1.389	1.387	1.384	1.381	1.378	1.376	1.373	1.370
102	1.368	1.365	1.362	1.360	1.357	1.354	1.352	1.349	1.346	1.344
103	1.341	1.339	1.336	1.333	1.331	1.328	1.326	1.323	1.321	1.318
104	1.316	1.313	1.311	1.308	1.305	1.303	1.301	1.298	1.296	1.293
105	1.291	1.288	1.286	1.283	1.281	1.278	1.276	1.274	1.271	1.269
106	1.266	1.264	1.262	1.259	1.257	1.255	1.252	1.250	1.247	1.245
107	1.243	1.240	1.238	1.236	1.234	1.231	1.229	1.227	1.224	1.222
108	1.220	1.218	1.215	1.213	1.211	1.209	1.206	1.204	1.202	1.200
109	1.198	1.195	1.193	1.191	1.189	1.187	1.185	1.182	1.180	1.178
110	1.176	1.174	1.172	1.170	1.167	1.165	1.163	1.161	1.159	1.157
111	1.155	1.153	1.151	1.149	1.147	1.145	1.142	1.140	1.138	1.136
112	1.134	1.132	1.130	1.128	1.126	1.124	1.122	1.120	1.118	1.116
113	1.114	1.112	1.110	1.108	1.106	1.105	1.103	1.101	1.099	1.097
114	1.095	1.093	1.091	1.089	1.087	1.085	1.083	1.082	1.080	1.078
115	1.076	1.074	1.072	1.070	1.068	1.067	1.065	1.063	1.061	1.059
116	1.057	1.056	1.054	1.052	1.050	1.048	1.047	1.045	1.043	1.041
117	1.039	1.038	1.036	1.034	1.032	1.031	1.029	1.027	1.025	1.024
118	1.022	1.020	1.018	1.017	1.015	1.013	1.012	1.010	1.008	1.006
119	1.005	1.003	1.001	0.9998	0.9981	0.9964	0.9947	0.9931	0.9914	0.9898
120	0.9881	0.9865	0.9848	0.9832	0.9816	0.9799	0.9783	0.9767	0.9751	0.9735
121	0.9719	0.9703	0.9687	0.9671	0.9655	0.9639	0.9623	0.9607	0.9591	0.9576
122	0.9560	0.9544	0.9529	0.9513	0.9498	0.9482	0.9467	0.9451	0.9436	0.9420
123	0.9405	0.9390	0.9375	0.9359	0.9344	0.9329	0.9314	0.9299	0.9284	0.9269
124	0.9254	0.9239	0.9224	0.9209	0.9195	0.9180	0.9165	0.9150	0.9136	0.9121
125	0.9107	0.9092	0.9078	0.9063	0.9049	0.9034	0.9020	0.9005	0.8991	0.8977
126	0.8963	0.8948	0.8934	0.8920	0.8906	0.8892	0.8878	0.8864	0.8850	0.8836
127	0.8822	0.8808	0.8794	0.8780	0.8767	0.8753	0.8739	0.8726	0.8712	0.8698
128	0.8685	0.8671	0.8658	0.8644	0.8631	0.8617	0.8604	0.8591	0.8577	0.8564
129	0.8551	0.8537	0.8524	0.8511	0.8498	0.8485	0.8472	0.8459	0.8446	0.8433
130	0.8420	0.8407	0.8394	0.8381	0.8368	0.8355	0.8343	0.8330	0.8317	0.8304
131	0.8291	0.8279	0.8266	0.8254	0.8241	0.8229	0.8216	0.8204	0.8191	0.8179
132	0.8166	0.8154	0.8142	0.8129	0.8117	0.8105	0.8093	0.8080	0.8068	0.8056
133	0.8044	0.8032	0.8020	0.8008	0.7996	0.7984	0.7972	0.7960	0.7948	0.7936
134	0.7924	0.7913	0.7901	0.7889	0.7877	0.7866	0.7854	0.7842	0.7831	0.7819
135	0.7807	0.7796	0.7784	0.7773	0.7761	0.7750	0.7738	0.7727	0.7716	0.7704
136	0.7693	0.7682	0.7670	0.7659	0.7648	0.7637	0.7626	0.7614	0.7603	0.7592
137	0.7581	0.7570	0.7559	0.7548	0.7537	0.7526	0.7515	0.7504	0.7493	0.7483
138	0.7472	0.7461	0.7450	0.7439	0.7429	0.7418	0.7407	0.7396	0.7386	0.7375
139	0.7365	0.7354	0.7343	0.7333	0.7322	0.7312	0.7301	0.7291	0.7281	0.7270
140	0.7260	0.7249	0.7239	0.7229	0.7218	0.7208	0.7198	0.7188	0.7177	0.7167
141	0.7157	0.7147	0.7137	0.7127	0.7117	0.7107	0.7097	0.7087	0.7077	0.7067
142	0.7057	0.7047	0.7037	0.7027	0.7017	0.7007	0.6997	0.6988	0.6978	0.6968
143	0.6958	0.6949	0.6939	0.6929	0.6920	0.6910	0.6900	0.6891	0.6881	0.6872
144	0.6862	0.6852	0.6843	0.6834	0.6824	0.6815	0.6805	0.6796	0.6786	0.6777
145	0.6768	0.6758	0.6749	0.6740	0.6731	0.6721	0.6712	0.6703	0.6694	0.6684
146	0.6675	0.6666	0.6657	0.6648	0.6639	0.6630	0.6621	0.6612	0.6603	0.6594
147	0.6585	0.6576	0.6567	0.6558	0.6549	0.6540	0.6531	0.6523	0.6514	0.6505
148	0.6496	0.6487	0.6479	0.6470	0.6461	0.6452	0.6444	0.6435	0.6426	0.6418
149	0.6409	0.6401	0.6392	0.6383	0.6375	0.6366	0.6358	0.6349	0.6341	0.6332

TABLE X6.1 *Continued*

Diagonal of Impression, μm	Knoop Hardness Number for Diagonal Measured to 0.1 μm									
	0.0	0.1	0.2	0.3	0.4	0.5	0.6	0.7	0.8	0.9
150	0.6324	0.6316	0.6307	0.6299	0.6290	0.6282	0.6274	0.6265	0.6257	0.6249
151	0.6241	0.6232	0.6224	0.6216	0.6208	0.6199	0.6191	0.6183	0.6175	0.6167
152	0.6159	0.6151	0.6143	0.6134	0.6126	0.6118	0.6110	0.6102	0.6094	0.6086
153	0.6078	0.6071	0.6063	0.6055	0.6047	0.6039	0.6031	0.6023	0.6015	0.6008
154	0.6000	0.5992	0.5984	0.5976	0.5969	0.5961	0.5953	0.5946	0.5938	0.5930
155	0.5923	0.5915	0.5907	0.5900	0.5892	0.5885	0.5877	0.5869	0.5862	0.5854
156	0.5847	0.5839	0.5832	0.5825	0.5817	0.5810	0.5802	0.5795	0.5787	0.5780
157	0.5773	0.5765	0.5758	0.5751	0.5743	0.5736	0.5729	0.5722	0.5714	0.5707
158	0.5700	0.5693	0.5685	0.5678	0.5671	0.5664	0.5657	0.5650	0.5643	0.5635
159	0.5628	0.5621	0.5614	0.5607	0.5600	0.5593	0.5586	0.5579	0.5572	0.5565
160	0.5558	0.5551	0.5544	0.5537	0.5531	0.5524	0.5517	0.5510	0.5503	0.5496
161	0.5489	0.5483	0.5476	0.5469	0.5462	0.5455	0.5449	0.5442	0.5435	0.5429
162	0.5422	0.5415	0.5408	0.5402	0.5395	0.5389	0.5382	0.5375	0.5369	0.5362
163	0.5356	0.5349	0.5342	0.5336	0.5329	0.5323	0.5316	0.5310	0.5303	0.5297
164	0.5290	0.5284	0.5278	0.5271	0.5265	0.5258	0.5252	0.5246	0.5239	0.5233
165	0.5226	0.5220	0.5214	0.5208	0.5201	0.5195	0.5189	0.5182	0.5176	0.5170
166	0.5164	0.5157	0.5151	0.5145	0.5139	0.5133	0.5127	0.5120	0.5114	0.5108
167	0.5102	0.5096	0.5090	0.5084	0.5078	0.5072	0.5066	0.5060	0.5054	0.5047
168	0.5041	0.5035	0.5030	0.5024	0.5018	0.5012	0.5006	0.5000	0.4994	0.4988
169	0.4982	0.4976	0.4970	0.4964	0.4959	0.4953	0.4947	0.4941	0.4935	0.4929
170	0.4924	0.4918	0.4912	0.4906	0.4900	0.4895	0.4889	0.4883	0.4878	0.4872
171	0.4866	0.4860	0.4855	0.4849	0.4843	0.4838	0.4832	0.4827	0.4821	0.4815
172	0.4810	0.4804	0.4799	0.4793	0.4787	0.4782	0.4776	0.4771	0.4765	0.4760
173	0.4754	0.4749	0.4743	0.4738	0.4732	0.4727	0.4721	0.4716	0.4711	0.4705
174	0.4700	0.4694	0.4689	0.4684	0.4678	0.4673	0.4668	0.4662	0.4657	0.4652
175	0.4646	0.4641	0.4636	0.4630	0.4625	0.4620	0.4615	0.4609	0.4604	0.4599
176	0.4594	0.4588	0.4583	0.4578	0.4573	0.4568	0.4562	0.4557	0.4552	0.4547
177	0.4542	0.4537	0.4532	0.4526	0.4521	0.4516	0.4511	0.4506	0.4501	0.4496
178	0.4491	0.4486	0.4481	0.4476	0.4471	0.4466	0.4461	0.4456	0.4451	0.4446
179	0.4441	0.4436	0.4431	0.4426	0.4421	0.4416	0.4411	0.4406	0.4401	0.4397
180	0.4392	0.4387	0.4382	0.4377	0.4372	0.4367	0.4363	0.4358	0.4353	0.4348
181	0.4343	0.4339	0.4334	0.4329	0.4324	0.4319	0.4315	0.4310	0.4305	0.4300
182	0.4296	0.4291	0.4286	0.4282	0.4277	0.4272	0.4268	0.4263	0.4258	0.4254
183	0.4249	0.4244	0.4240	0.4235	0.4230	0.4226	0.4221	0.4217	0.4212	0.4207
184	0.4203	0.4198	0.4194	0.4189	0.4185	0.4180	0.4176	0.4171	0.4167	0.4162
185	0.4158	0.4153	0.4149	0.4144	0.4140	0.4135	0.4131	0.4126	0.4122	0.4117
186	0.4113	0.4109	0.4104	0.4100	0.4095	0.4091	0.4087	0.4082	0.4078	0.4073
187	0.4069	0.4065	0.4060	0.4056	0.4052	0.4047	0.4043	0.4039	0.4034	0.4030
188	0.4026	0.4022	0.4017	0.4013	0.4009	0.4005	0.4000	0.3996	0.3992	0.3988
189	0.3983	0.3979	0.3975	0.3971	0.3967	0.3962	0.3958	0.3954	0.3950	0.3946
190	0.3942	0.3937	0.3933	0.3929	0.3925	0.3921	0.3917	0.3913	0.3909	0.3905
191	0.3900	0.3896	0.3892	0.3888	0.3884	0.3880	0.3876	0.3872	0.3868	0.3864
192	0.3860	0.3856	0.3852	0.3848	0.3844	0.3840	0.3836	0.3832	0.3828	0.3824
193	0.3820	0.3816	0.3812	0.3808	0.3804	0.3800	0.3796	0.3792	0.3789	0.3785
194	0.3781	0.3777	0.3773	0.3769	0.3765	0.3761	0.3757	0.3754	0.3750	0.3746
195	0.3742	0.3738	0.3734	0.3731	0.3727	0.3723	0.3719	0.3715	0.3712	0.3708
196	0.3704	0.3700	0.3696	0.3693	0.3689	0.3685	0.3681	0.3678	0.3674	0.3670
197	0.3663	0.3663	0.3659	0.3655	0.3652	0.3648	0.3644	0.3641	0.3637	0.3633
198	0.3630	0.3626	0.3622	0.3619	0.3615	0.3611	0.3608	0.3604	0.3600	0.3597
199	0.3593	0.3590	0.3586	0.3582	0.3579	0.3575	0.3572	0.3568	0.3564	0.3561
200	0.3557	0.3554	0.3550	0.3547	0.3543	0.3540	0.3536	0.3533	0.3529	0.3525

^A † Corrected.

TABLE X6.2 Vickers Hardness Numbers for Load of 1 gf

Diagonal of Impression, μm	Vickers Hardness Number for Diagonal Measured to 0.1 μm									
	0.0	0.1	0.2	0.3	0.4	0.5	0.6	0.7	0.8	0.9
1	1854.6	1533.5	1288	1097.5	946.1	824.2	724.4	641.6	572.3	513.7
2	463.0	420.0	383.1	350.3	321.9	296.7	274.3	254.4	236.5	220.5
3	206.9	193.3	181.1	170.3	160.4	151.4	143.1	135.5	128.4	121.9
4	115.17	110.29	105.58	100.01	95.78	91.57	87.64	83.95	80.48	77.23
5	74	71	68	66	63.59	61.30	59.13	57.07	55.12	53.27
6	51.51	49.83	48.24	46.72	45.27	43.89	42.57	41.31	40.10	38.95
7	37.84	36.79	35.77	34.80	33.86	32.97	32.10	31.28	30.48	29.71
8	28.97	28.26	27.58	26.92	26.28	25.67	25.07	24.50	23.95	23.41
9	22.89	22.39	21.91	21.44	20.99	20.55	20.12	19.71	19.31	18.92
10	18.54	18.18	17.82	17.48	17.14	16.82	16.50	16.20	15.90	15.61
11	15.33	15.05	14.78	14.52	14.27	14.02	13.78	13.55	13.32	13.09
12	12.88	12.67	12.46	12.26	12.06	11.87	11.68	11.50	11.32	11.14
13	10.97	10.81	10.64	10.48	10.33	10.17	10.03	9.880	9.737	9.598
14	9.461	9.327	9.196	9.068	8.943	8.820	8.699	8.581	8.466	8.353
15	8.242	8.133	8.026	7.922	7.819	7.718	7.620	7.523	7.428	7.335
16	7.244	7.154	7.066	6.979	6.895	6.811	6.729	6.649	6.570	6.493
17	6.416	6.342	6.268	6.196	6.125	6.055	5.986	5.919	5.853	5.787
18	5.723	5.660	5.598	5.537	5.477	5.418	5.360	5.303	5.247	5.191
19	5.137	5.083	5.030	4.978	4.927	4.877	4.827	4.778	4.730	4.683
20	4.636	4.590	4.545	4.500	4.456	4.413	4.370	4.328	4.286	4.245
21	4.205	4.165	4.126	4.087	4.049	4.012	3.975	3.938	3.902	3.866
22	3.831	3.797	3.763	3.729	3.696	3.663	3.631	3.599	3.587	3.536
23	3.505	3.475	3.445	3.416	3.387	3.358	3.329	3.301	3.274	3.246
24	3.219	3.193	3.166	3.140	3.115	3.089	3.064	3.039	3.015	2.991
25	2.967	2.943	2.920	2.897	2.874	2.852	2.830	2.808	2.786	2.764
26	2.743	2.722	2.701	2.681	2.661	2.641	2.621	2.601	2.582	2.563
27	2.544	2.525	2.506	2.488	2.470	2.452	2.434	2.417	2.399	2.382
28	2.365	2.348	2.332	2.315	2.299	2.283	2.267	2.251	2.236	2.220
29	2.205	2.190	2.175	2.160	2.145	2.131	2.116	2.102	2.088	2.074
30	2.060	2.047	2.033	2.020	2.007	1.993	1.980	1.968	1.955	1.942
31	1.930	1.917	1.905	1.893	1.881	1.869	1.857	1.845	1.834	1.822
32	1.811	1.800	1.788	1.777	1.766	1.756	1.745	1.734	1.724	1.713
33	1.703	1.693	1.682	1.672	1.662	1.652	1.643	1.633	1.623	1.614
34	1.604	1.595	1.585	1.576	1.567	1.558	1.549	1.540	1.531	1.522
35	1.514	1.505	1.497	1.488	1.480	1.471	1.463	1.455	1.447	1.439
36	1.431	1.423	1.415	1.407	1.400	1.392	1.384	1.377	1.369	1.362
37	1.355	1.347	1.340	1.333	1.326	1.319	1.312	1.305	1.298	1.291
38	1.284	1.277	1.271	1.264	1.258	1.251	1.245	1.238	1.232	1.225
39	1.219	1.213	1.207	1.201	1.195	1.189	1.183	1.177	1.171	1.165
40	1.159	1.153	1.147	1.142	1.136	1.131	1.125	1.119	1.114	1.109
41	1.103	1.098	1.092	1.087	1.082	1.077	1.072	1.066	1.061	1.056
42	1.051	1.046	1.041	1.036	1.031	1.027	1.022	1.017	1.012	1.008
43	0.003	0.9983	0.9936	0.9891	0.9845	0.9800	0.9755	0.9710	0.9666	0.9622
44	0.9578	0.9535	0.9492	0.9449	0.9407	0.9364	0.9322	0.9281	0.9239	0.9198
45	0.9157	0.9117	0.9077	0.9036	0.8997	0.8957	0.8918	0.8879	0.8840	0.8802
46	0.8764	0.8726	0.8688	0.8650	0.8613	0.8576	0.8539	0.8503	0.8467	0.8430
47	0.8395	0.8359	0.8324	0.8288	0.8254	0.8219	0.8184	0.8150	0.8116	0.8082
48	0.8048	0.8015	0.7982	0.7949	0.7916	0.7883	0.7851	0.7819	0.7787	0.7755
49	0.7723	0.7692	0.7661	0.7630	0.7599	0.7568	0.7538	0.7507	0.7477	0.7447
50	0.7417	0.7388	0.7359	0.7329	0.7300	0.7271	0.7243	0.7214	0.7186	0.7158
51	0.7129	0.7102	0.7074	0.7046	0.7019	0.6992	0.6965	0.6938	0.6911	0.6884
52	0.6858	0.6832	0.6805	0.6779	0.6754	0.6728	0.6702	0.6677	0.6652	0.6627
53	0.6602	0.6577	0.6552	0.6527	0.6503	0.6479	0.6455	0.6431	0.6407	0.6383
54	0.6359	0.6336	0.6312	0.6289	0.6266	0.6243	0.6220	0.6198	0.6175	0.6153
55	0.6130	0.6108	0.6086	0.6064	0.6042	0.6020	0.5999	0.5977	0.5956	0.5934
56	0.5913	0.5892	0.5871	0.5850	0.5830	0.5809	0.5788	0.5768	0.5748	0.5728
57	0.5708	0.5688	0.5668	0.5648	0.5628	0.5609	0.5589	0.5570	0.5551	0.5531
58	0.5512	0.5493	0.5475	0.5456	0.5437	0.5419	0.5400	0.5382	0.5363	0.5345
59	0.5327	0.5309	0.5291	0.5273	0.5256	0.5238	0.5220	0.5203	0.5186	0.5168
60	0.5151	0.5134	0.5117	0.5100	0.5083	0.5066	0.5050	0.5033	0.5016	0.5000

TABLE X6.2 *Continued*

Diagonal of Impression, μm	Vickers Hardness Number for Diagonal Measured to 0.1 μm									
	0.0	0.1	0.2	0.3	0.4	0.5	0.6	0.7	0.8	0.9
61	0.4984	0.4967	0.4951	0.4935	0.4919	0.4903	0.4887	0.4871	0.4855	0.4840
62	0.4824	0.4809	0.4793	0.4778	0.4762	0.4747	0.4732	0.4717	0.4702	0.4687
63	0.4672	0.4657	0.4643	0.4628	0.4613	0.4599	0.4584	0.4570	0.4556	0.4541
64	0.4527	0.4513	0.4499	0.4485	0.4471	0.4457	0.4444	0.4430	0.4416	0.4403
65	0.4389	0.4376	0.4362	0.4349	0.4336	0.4322	0.4309	0.4296	0.4283	0.4270
66	0.4257	0.4244	0.4231	0.4219	0.4206	0.4193	0.4181	0.4168	0.4156	0.4143
67	0.4131	0.4119	0.4106	0.4094	0.4082	0.4070	0.4058	0.4046	0.4034	0.4022
68	0.4010	0.3999	0.3987	0.3975	0.3964	0.3952	0.3941	0.3929	0.3918	0.3906
69	0.3895	0.3884	0.3872	0.3861	0.3850	0.3839	0.3828	0.3817	0.3806	0.3795
70	0.3784	0.3774	0.3763	0.3752	0.3742	0.3731	0.3720	0.3710	0.3699	0.3689
71	0.3679	0.3668	0.3658	0.3648	0.3638	0.3627	0.3617	0.3607	0.3597	0.3587
72	0.3577	0.3567	0.3557	0.3548	0.3538	0.3528	0.3518	0.3509	0.3499	0.3489
73	0.3480	0.3470	0.3461	0.3451	0.3442	0.3433	0.3423	0.3414	0.3405	0.3396
74	0.3386	0.3377	0.3368	0.3359	0.3350	0.3341	0.3332	0.3323	0.3314	0.3305
75	0.3297	0.3288	0.3279	0.3270	0.3262	0.3253	0.3245	0.3236	0.3227	0.3219
76	0.3211	0.3202	0.3194	0.3185	0.3177	0.3169	0.3160	0.3152	0.3144	0.3136
77	0.3128	0.3120	0.3111	0.3103	0.3095	0.3087	0.3079	0.3072	0.3064	0.3056
78	0.3048	0.3040	0.3032	0.3025	0.3017	0.3009	0.3002	0.2994	0.2986	0.2979
79	0.2971	0.2964	0.2956	0.2949	0.2941	0.2934	0.2927	0.2919	0.2912	0.2905
80	0.2897	0.2890	0.2883	0.2876	0.2869	0.2862	0.2855	0.2847	0.2840	0.2833
81	0.2826	0.2819	0.2812	0.2806	0.2799	0.2792	0.2785	0.2778	0.2771	0.2765
82	0.2758	0.2751	0.2744	0.2738	0.2731	0.2725	0.2718	0.2711	0.2705	0.2698
83	0.2692	0.2685	0.2677	0.2672	0.2666	0.2660	0.2653	0.2647	0.2641	0.2634
84	0.2628	0.2622	0.2616	0.2609	0.2603	0.2597	0.2591	0.2585	0.2579	0.2573
85	0.2567	0.2561	0.2555	0.2549	0.2543	0.2537	0.2531	0.2525	0.2519	0.2513
86	0.2507	0.2501	0.2496	0.2490	0.2484	0.2478	0.2473	0.2467	0.2461	0.2456
87	0.2450	0.2444	0.2439	0.2433	0.2428	0.2422	0.2417	0.2411	0.2406	0.2400
88	0.2395	0.2389	0.2384	0.2378	0.2373	0.2368	0.2362	0.2357	0.2352	0.2346
89	0.2341	0.2336	0.2331	0.2325	0.2320	0.2315	0.2310	0.2305	0.2300	0.2294
90	0.2289	0.2284	0.2279	0.2274	0.2269	0.2264	0.2259	0.2254	0.2249	0.2244
91	0.2239	0.2234	0.2230	0.2225	0.2220	0.2215	0.2210	0.2205	0.2200	0.2196
92	0.2191	0.2186	0.2181	0.2177	0.2172	0.2167	0.2163	0.2158	0.2153	0.2149
93	0.2144	0.2139	0.2135	0.2130	0.2126	0.2121	0.2117	0.2112	0.2108	0.2103
94	0.2099	0.2094	0.2090	0.2085	0.2081	0.2077	0.2072	0.2068	0.2063	0.2059
95	0.2055	0.2050	0.2046	0.2042	0.2038	0.2033	0.2029	0.2025	0.2021	0.2016
96	0.2012	0.2008	0.2004	0.2000	0.1995	0.1991	0.1987	0.1983	0.1979	0.1975
97	0.1971	0.1967	0.1963	0.1959	0.1955	0.1951	0.1947	0.1943	0.1939	0.1935
98	0.1931	0.1927	0.1923	0.1919	0.1915	0.1911	0.1907	0.1904	0.1900	0.1896
99	0.1892	0.1888	0.1884	0.1881	0.1877	0.1873	0.1869	0.1866	0.1862	0.1858
100	0.1854	0.1851	0.1847	0.1843	0.1840	0.1836	0.1832	0.1829	0.1825	0.1821
101	0.1818	0.1814	0.1811	0.1807	0.1804	0.1800	0.1796	0.1793	0.1789	0.1786
102	0.1782	0.1779	0.1775	0.1772	0.1769	0.1765	0.1762	0.1758	0.1755	0.1751
103	0.1748	0.1745	0.1741	0.1738	0.1734	0.1731	0.1728	0.1724	0.1721	0.1718
104	0.1715	0.1711	0.1708	0.1705	0.1701	0.1698	0.1695	0.1692	0.1688	0.1685
105	0.1682	0.1679	0.1676	0.1672	0.1669	0.1666	0.1663	0.1660	0.1657	0.1654
106	0.1650	0.1647	0.1644	0.1641	0.1638	0.1635	0.1632	0.1629	0.1626	0.1623
107	0.1620	0.1617	0.1614	0.1611	0.1608	0.1605	0.1602	0.1599	0.1596	0.1593
108	0.1590	0.1587	0.1584	0.1581	0.1578	0.1575	0.1572	0.1569	0.1567	0.1564
109	0.1561	0.1556	0.1555	0.1552	0.1549	0.1547	0.1544	0.1541	0.1538	0.1535
110	0.1533	0.1530	0.1527	0.1524	0.1521	0.1519	0.1516	0.1513	0.1511	0.1508
111	0.1505	0.1502	0.1500	0.1497	0.1494	0.1492	0.1489	0.1486	0.1484	0.1481
112	0.1478	0.1476	0.1473	0.1470	0.1468	0.1465	0.1463	0.1460	0.1457	0.1455
113	0.1452	0.1450	0.1447	0.1445	0.1442	0.1440	0.1437	0.1434	0.1432	0.1429
114	0.1427	0.1424	0.1422	0.1419	0.1417	0.1414	0.1412	0.1410	0.1407	0.1405
115	0.1402	0.1400	0.1397	0.1395	0.1393	0.1390	0.1388	0.1385	0.1383	0.1381
116	0.1378	0.1376	0.1373	0.1371	0.1369	0.1366	0.1364	0.1362	0.1359	0.1357
117	0.1355	0.1352	0.1350	0.1348	0.1345	0.1343	0.1341	0.1339	0.1336	0.1334
118	0.1332	0.1330	0.1327	0.1325	0.1323	0.1321	0.1318	0.1316	0.1314	0.1312
119	0.1310	0.1307	0.1305	0.1303	0.1301	0.1299	0.1296	0.1294	0.1292	0.1290
120	0.1288	0.1286	0.1284	0.1281	0.1279	0.1277	0.1275	0.1273	0.1271	0.1269
121	0.1267	0.1265	0.1262	0.1260	0.1258	0.1256	0.1254	0.1252	0.1250	0.1248

TABLE X6.2 *Continued*

Diagonal of Impression, μm	Vickers Hardness Number for Diagonal Measured to 0.1 μm									
	0.0	0.1	0.2	0.3	0.4	0.5	0.6	0.7	0.8	0.9
122	0.1246	0.1244	0.1242	0.1240	0.1238	0.1236	0.1234	0.1232	0.1230	0.1228
123	0.1226	0.1224	0.1222	0.1220	0.1218	0.1216	0.1214	0.1212	0.1210	0.1208
124	0.1206	0.1204	0.1202	0.1200	0.1198	0.1196	0.1194	0.1193	0.1191	0.1189
125	0.1187	0.1185	0.1183	0.1181	0.1179	0.1177	0.1176	0.1174	0.1172	0.1170
126	0.1168	0.1166	0.1164	0.1163	0.1161	0.1159	0.1157	0.1155	0.1153	0.1152
127	0.1150	0.1148	0.1146	0.1144	0.1143	0.1141	0.1139	0.1137	0.1135	0.1134
128	0.1132	0.1130	0.1128	0.1127	0.1125	0.1123	0.1121	0.1120	0.1118	0.1116
129	0.1114	0.1113	0.1111	0.1109	0.1108	0.1106	0.1104	0.1102	0.1101	0.1099
130	0.1097	0.1096	0.1094	0.1092	0.1091	0.1089	0.1087	0.1086	0.1084	0.1082
131	0.1081	0.1079	0.1077	0.1076	0.1074	0.1072	0.1071	0.1069	0.1068	0.1066
132	0.1064	0.1063	0.1061	0.1059	0.1058	0.1056	0.1055	0.1053	0.1052	0.1050
133	0.1048	0.1047	0.1045	0.1044	0.1042	0.1041	0.1039	0.1037	0.1036	0.1034
134	0.1033	0.1031	0.1030	0.1028	0.1027	0.1025	0.1024	0.1022	0.1021	0.1019
135	0.1018	0.1016	0.1015	0.1013	0.1012	0.1010	0.1009	0.1007	0.1006	0.1004
136	0.1003	0.1001	0.1000	0.0998	0.0997	0.0995	0.0994	0.0992	0.0991	0.0989
137	0.0988	0.0987	0.0985	0.0984	0.0982	0.0981	0.0979	0.0978	0.0977	0.0975
138	0.0974	0.0972	0.0971	0.0970	0.0968	0.0967	0.0965	0.0964	0.0963	0.0961
139	0.0960	0.0958	0.0957	0.0956	0.0954	0.0953	0.0952	0.0950	0.0949	0.0948
140	0.0946	0.0945	0.0943	0.0942	0.0941	0.0939	0.0938	0.0937	0.0935	0.0934
141	0.0933	0.0931	0.0930	0.0929	0.0928	0.0926	0.0925	0.0924	0.0922	0.0921
142	0.0920	0.0918	0.0917	0.0916	0.0915	0.0913	0.0912	0.0911	0.0909	0.0908
143	0.0907	0.0906	0.0904	0.0903	0.0902	0.0901	0.0899	0.0898	0.0897	0.0896
144	0.0894	0.0893	0.0892	0.0891	0.0889	0.0888	0.0887	0.0886	0.0884	0.0883
145	0.0882	0.0881	0.0880	0.0878	0.0877	0.0876	0.0875	0.0874	0.0872	0.0871
146	0.0870	0.0869	0.0868	0.0866	0.0865	0.0864	0.0863	0.0862	0.0861	0.0859
147	0.0858	0.0857	0.0856	0.0855	0.0854	0.0852	0.0851	0.0850	0.0849	0.0848
148	0.0847	0.0845	0.0844	0.0843	0.0842	0.0841	0.0840	0.0839	0.0838	0.0836
149	0.0835	0.0834	0.0833	0.0832	0.0831	0.0830	0.0829	0.0828	0.0826	0.0825
150	0.0824	0.0823	0.0822	0.0821	0.0820	0.0819	0.0818	0.0817	0.0815	0.0814
151	0.0813	0.0812	0.0811	0.0810	0.0809	0.0808	0.0807	0.0806	0.0805	0.0804
152	0.0803	0.0802	0.0801	0.0800	0.0798	0.0797	0.0796	0.0795	0.0794	0.0793
153	0.0792	0.0791	0.0790	0.0789	0.0788	0.0787	0.0786	0.0785	0.0784	0.0783
154	0.0782	0.0781	0.0780	0.0779	0.0778	0.0777	0.0776	0.0775	0.0774	0.0773
155	0.0772	0.0771	0.0770	0.0769	0.0768	0.0767	0.0766	0.0765	0.0764	0.0763
156	0.0762	0.0761	0.0760	0.0759	0.0758	0.0757	0.0756	0.0755	0.0754	0.0753
157	0.0752	0.0751	0.0750	0.0749	0.0749	0.0748	0.0747	0.0746	0.0745	0.0744
158	0.0743	0.0742	0.0741	0.0740	0.0739	0.0738	0.0737	0.0736	0.0735	0.0734
159	0.0734	0.0733	0.0732	0.0731	0.0730	0.0729	0.0728	0.0727	0.0726	0.0725
160	0.0724	0.0724	0.0723	0.0722	0.0721	0.0720	0.0719	0.0718	0.0717	0.0716
161	0.0715	0.0715	0.0714	0.0713	0.0712	0.0711	0.0710	0.0709	0.0708	0.0708
162	0.0707	0.0706	0.0705	0.0704	0.0703	0.0702	0.0701	0.0701	0.0700	0.0699
163	0.0698	0.0697	0.0696	0.0695	0.0695	0.0694	0.0693	0.0692	0.0691	0.0690
164	0.0690	0.0689	0.0688	0.0687	0.0686	0.0685	0.0684	0.0684	0.0683	0.0682
165	0.0681	0.0680	0.0680	0.0679	0.0678	0.0677	0.0676	0.0675	0.0675	0.0674
166	0.0673	0.0672	0.0671	0.0671	0.0670	0.0669	0.0668	0.0667	0.0667	0.0666
167	0.0665	0.0664	0.0663	0.0663	0.0662	0.0661	0.0660	0.0659	0.0659	0.0658
168	0.0657	0.0656	0.0656	0.0655	0.0654	0.0653	0.0652	0.0652	0.0651	0.0650
169	0.0649	0.0649	0.0648	0.0647	0.0646	0.0645	0.0645	0.0644	0.0643	0.0642
170	0.0642	0.0641	0.0640	0.0639	0.0639	0.0638	0.0637	0.0636	0.0636	0.0635
171	0.0634	0.0633	0.0633	0.0632	0.0631	0.0631	0.0630	0.0629	0.0628	0.0628
172	0.0627	0.0626	0.0625	0.0625	0.0624	0.0623	0.0623	0.0622	0.0621	0.0620
173	0.0620	0.0619	0.0618	0.0617	0.0617	0.0616	0.0615	0.0615	0.0614	0.0613
174	0.0613	0.0612	0.0611	0.0610	0.0610	0.0609	0.0608	0.0608	0.0607	0.0606
175	0.0606	0.0605	0.0604	0.0603	0.0603	0.0602	0.0601	0.0601	0.0600	0.0559
176	0.0599	0.0598	0.0597	0.0597	0.0596	0.0595	0.0595	0.0594	0.0593	0.0593
177	0.0592	0.0591	0.0591	0.0590	0.0589	0.0589	0.0588	0.0587	0.0587	0.0586
178	0.0585	0.0585	0.0584	0.0583	0.0583	0.0582	0.0581	0.0581	0.0580	0.0579
179	0.0579	0.0578	0.0578	0.0577	0.0576	0.0576	0.0575	0.0574	0.0574	0.0573
180	0.0572	0.0572	0.0571	0.0570	0.0570	0.0569	0.0569	0.0568	0.0567	0.0567
181	0.0566	0.0565	0.0565	0.0564	0.0564	0.0563	0.0562	0.0562	0.0561	0.0560
182	0.0560	0.0559	0.0559	0.0558	0.0557	0.0557	0.0556	0.0556	0.0555	0.0554

TABLE X6.2 *Continued*

Diagonal of Impression, μm	Vickers Hardness Number for Diagonal Measured to 0.1 μm									
	0.0	0.1	0.2	0.3	0.4	0.5	0.6	0.7	0.8	0.9
183	0.0554	0.0553	0.0553	0.0552	0.0551	0.0551	0.0550	0.0550	0.0549	0.0548
184	0.0548	0.0547	0.0547	0.0546	0.0545	0.0545	0.0544	0.0544	0.0543	0.0542
185	0.0542	0.0541	0.0541	0.0540	0.0540	0.0539	0.0538	0.0538	0.0537	0.0537
186	0.0536	0.0535	0.0535	0.0534	0.0534	0.0533	0.0533	0.0532	0.0531	0.0531
187	0.0530	0.0530	0.0529	0.0529	0.0528	0.0528	0.0527	0.0526	0.0526	0.0525
188	0.0525	0.0524	0.0524	0.0523	0.0522	0.0522	0.0521	0.0521	0.0520	0.0520
189	0.0519	0.0519	0.0518	0.0518	0.0517	0.0516	0.0516	0.0515	0.0515	0.0514
190	0.0514	0.0513	0.0513	0.0512	0.0512	0.0511	0.0510	0.0510	0.0509	0.0509
191	0.0508	0.0508	0.0507	0.0507	0.0506	0.0506	0.0505	0.0505	0.0504	0.0504
192	0.0503	0.0503	0.0502	0.0502	0.0501	0.0500	0.0500	0.0499	0.0499	0.0498
193	0.0498	0.0497	0.0497	0.0496	0.0496	0.0495	0.0495	0.0494	0.0494	0.0493
194	0.0493	0.0492	0.0492	0.0491	0.0491	0.0490	0.0490	0.0489	0.0489	0.0488
195	0.0488	0.0487	0.0487	0.0486	0.0486	0.0485	0.0485	0.0484	0.0484	0.0483
196	0.0483	0.0482	0.0482	0.0481	0.0481	0.0480	0.0480	0.0479	0.0479	0.0478
197	0.0478	0.0477	0.0477	0.0476	0.0476	0.0475	0.0475	0.0474	0.0474	0.0474
198	0.0473	0.0473	0.0472	0.0472	0.0471	0.0471	0.0470	0.0470	0.0469	0.0469
199	0.0468	0.0468	0.0467	0.0467	0.0466	0.0466	0.0465	0.0465	0.0465	0.0464
200	0.0464	0.0463	0.0463	0.0462	0.0462	0.0461	0.0461	0.0460	0.0460	0.0459

X7. REVISIONS

X7.1 New sections 10.8.5 through 10.8.8.

X7.3 New Appendix X4.

X7.2 New Annex A1.

REFERENCES

- (1) Campbell, R.F., et al., "A New Design of Microhardness Tester and Some Factors Affecting the Diamond Pyramid Hardness Number at Light Loads," Trans. ASM, Vol 40, 1948, pp. 954-982.
- (2) Kennedy, R.G., and Marrotte, N.W., "The Effect of Vibration on Microhardness Testing," *Materials Research and Standards*, Vol 9, November 1969, pp. 18-23.
- (3) Brown, A.R.G., and Ineson, E., "Experimental Survey of Low-Load Hardness Testing Instruments," *Journal of the Iron and Steel Inst.*, Vol 169, 1951, pp. 376-388.
- (4) Thibault, N.W., and Nyquist, H.L., "The Measured Knoop Hardness of Hard Substances and Factors Affecting Its Determination," Trans. ASM, Vol 38, 1947, pp. 271-330.
- (5) Tarasov, L.P., and Thibault, N.W., "Determination of Knoop Hardness Numbers Independent of Load," Trans. ASM, Vol 38, 1947, pp. 331-353.
- (6) Vander Voort, G.P., "Results of an ASTM E04 Round Robin on the Precision and Bias of Measurements of Microindentation Hardness," *Factors that Affect the Precision of Mechanical Tests, ASTM STP 1025*, ASTM, Philadelphia, 1989, pp. 3-39.
- (7) Vander Voort, G.F., "Operator Errors In the Measurement of Microindentation Hardness," *Accreditation Practices for Inspections, Tests, and Laboratories, ASTM STP 1057*, ASTM, Philadelphia, 1989, pp. 47-77.

ASTM International takes no position respecting the validity of any patent rights asserted in connection with any item mentioned in this standard. Users of this standard are expressly advised that determination of the validity of any such patent rights, and the risk of infringement of such rights, are entirely their own responsibility.

This standard is subject to revision at any time by the responsible technical committee and must be reviewed every five years and if not revised, either reapproved or withdrawn. Your comments are invited either for revision of this standard or for additional standards and should be addressed to ASTM International Headquarters. Your comments will receive careful consideration at a meeting of the responsible technical committee, which you may attend. If you feel that your comments have not received a fair hearing you should make your views known to the ASTM Committee on Standards, at the address shown below.

This standard is copyrighted by ASTM International, 100 Barr Harbor Drive, PO Box C700, West Conshohocken, PA 19428-2959, United States. Individual reprints (single or multiple copies) of this standard may be obtained by contacting ASTM at the above address or at 610-832-9585 (phone), 610-832-9555 (fax), or service@astm.org (e-mail); or through the ASTM website (www.astm.org).